

ANNEX TO THE CERTIFICATE

2619/0375-E3-CER

Important Note :

- This document is issued by the Company under its General Conditions of service accessible at http://www.sgs.com/terms_and_conditions.htm. Attention is drawn to the limitation of liability, indemnification and jurisdiction issues defined therein. Any holder of this document is advised that information contained hereon reflects the Company's findings at the time of its intervention only and within the limits of Client's instructions, if any. The Company's sole responsibility is to its Client and this document does not exonerate parties to a transaction from exercising all their rights and obligations under the transaction documents.
- Any unauthorized alteration, forgery or falsification of the content or appearance of this document is unlawful, and offenders may be prosecuted to the fullest extent of the law.
- Unless otherwise stated the results shown in this document refer only to the sample(s) tested as received. The Company SGS shall not be liable for any incorrect results arising from unclear, erroneous, incomplete, misleading or false information provided by Client. This document cannot be reproduced except in full, without prior approval of the Company.

Document Historical Revision:

Document Version	Date	Resume
Revision 0	02/03/2020	First issuance
Revision 1	27/07/2020	Modified to add evaluations of compliance with new tests performed to check Maximum Capabilities of operation of the certified unit. Further editorial changes are added.
Revision 2	21/01/2022	<p>The annex is modified as manufacturer has updated the Dynamic Simulation Model to version 3.0 to prevent the total current from exceeding the limit due to the output of negative sequence active current in case of some unbalanced faults.</p> <p>Added clause 3.1.3 to show which tests have been repeated and verify that updated model has not critical change to the previous version model</p> <p>The ISO 9001 Quality Management System Certificate of one of the manufacturers was updated because the current certificate was expired Manufacture corresponds to Sungrow Developers (India) Private Limited</p> <p>Further editorial changes are included</p>

Revision 3	10/02/2022	<p>The annex is modified to update MD5 Checksum reference in TG4 due to a typo in previous MD5 Checksum.</p> <p>The dynamic simulation model itself has not changed, therefore no further testing is required.</p> <p>Further editorial changes are included</p>
------------	------------	--

This document is created based on requirements of FGW Technical Guidelines for Power Generating Units, Systems and Storage Systems as well as for their Components. Part 8 (TG8). Certification of the Electrical Characteristics of Power Generating Units, Systems and Storage Systems as well as their Components on the Grid. Revision 09. Dated 01/02/2019.

0 1 2 3 4 5



INDEX

1	OVERVIEW OF THE FGW TR8 EVALUATION REPORT	4
1.1	INFORMATION ABOUT THE TESTED MODEL.....	5
1.2	SUMMARY OF THE EVALUATION OF THE TEST RESULTS.....	8
1.3	SUMMARY OF THE EVALUATION OF THE VALIDATION RESULTS.....	17
1.4	EVALUATION OF THE ISO 9001 QUALITY MANAGEMENT SYSTEM CERTIFICATE OF MANUFACTURERS.....	20
1.5	COMPROMISE LETTER TO MAINTAIN ISO 9001 DURING THE VALIDITY PERIOD OF CERTIFICATE	23
1.6	COMPROMISE LETTER OF THE CERTIFIED PRODUCT.....	24
2	OVERVIEW OF RESULTS OF THE FGW TR3 TEST REPORT	26
2.1	NENNDATEN / RATED DATA:.....	26
2.2	POWER QUALITY	26
2.2.1	Wirkleistungsspitzen / Power Peaks.....	26
2.2.2	Schalhandlungen / Switching Operation	27
2.2.3	Unsymmetrie / Unbalances	28
2.2.4	Flicker	28
2.2.5	Oberschwingungsmessungen / Harmonics	29
2.2.6	Zwischenharmonische / Interharmonics	30
2.2.7	Höhere Frequenzen / Higher Frequencies components.....	31
2.3	GRID CONTROL CAPABILITY.....	32
2.3.1	Wirkleistungs einspeisung in Abhängigkeit der Netzfrequenz / Active power vs frequency ...	32
2.3.2	Procedure for reactive power provision.....	34
2.3.3	Blindleistungsbereitstellung / Provision of reactive power	35
2.4	PROTECTION SYSTEM.....	38
2.4.1	Trennung der EZE vom Netz / Cut-off from grid.....	38
2.4.2	Zuschaltbedingungen / Cut-in conditions.....	39
2.4.3	Zuschaltbedingungen nach Auslösung des Entkopplungsschutzes / Cut-in conditions after tripping of protection	39
2.5	RESPONSE DURING GRID FAULTS.....	40
3	OVERVIEW OF RESULTS OF THE FGW TR4 VALIDATION REPORT.....	41
3.1	VALIDATION RESULTS.....	43
3.1.1	Validation overview	43
3.1.2	Additional tests.....	47
3.2	VALIDATION CONCLUSION	48
4	TECHNICAL DATA.....	49
4.1	TECHNICAL DATA	49
4.2	OVERVIEW OF IMPORTANT PARAMETERS OF THE GENERATION UNIT.....	50
4.3	ELECTRIC SCHEME	61
4.4	INTERFACES	62
4.5	MANUFACTURER'S CERTIFICATES FOR CERTIFIED PGUS ACCORDING TO FGW TG3.....	63
4.6	BEHAVIOUR IN THE EVENT OF A FAILURE OF EITHER THE PGP CONTROLLER OR THE ASSOCIATED MEASUREMENT OR THE CONNECTION BETWEEN PGP CONTROLLER AND PGU	64
5	DYNAMIC SIMUALTION MODEL INFORMATION	65
5.1	SOFTWARE CHARACTERISTICS.....	65
5.2	SOFTWARE INFORMATION AND COMMENTS.....	66
5.3	DESCRIPTION OF THE MODEL	67

1 OVERVIEW OF THE FGW TR8 EVALUATION REPORT

This point of this annex of the certificate no. 2619 / 0375 – E3 – CER contains the information of all items and documentation used for the evaluation of compliance of the certified product according to standards VDE-AR-N 4110: 2018-11, VDE-AR-N 4120:2018-11, FGW-Richlinie TR 3 Rev. 25 (including supplement 1, dated on 22/01/2019) and FGW-Richlinie TR 4 Rev. 9.

The information contained in this point is extracted from the SGS Evaluation Report Number: 2619 / 0375, rev3. With date on 10-02-2022 according of FGW TR8 rev. 9.

The evaluation performed by SGS comprises the checking in compliance with following requirements:

Evaluation:	Remarks	Result		
Keys: P.....Pass. NC.....Not Comply NA.....Not Applicable				
Checking of the PGU tested	See point 1.1 of this document	<input checked="" type="checkbox"/> P	<input type="checkbox"/> NC	<input type="checkbox"/> NA
Checking of the variant models to be included in the certification process	No variant models	<input type="checkbox"/> P	<input type="checkbox"/> NC	<input checked="" type="checkbox"/> NA
Review Test Report according FGW TG3 per VDE-AR-N 4110: 2018 certification	See point 1.2 of this document	<input checked="" type="checkbox"/> P	<input type="checkbox"/> NC	<input type="checkbox"/> NA
Review Test Report according FGW TG3 per VDE-AR-N 4120: 2018 certification	See point 1.2 of this document	<input checked="" type="checkbox"/> P	<input type="checkbox"/> NC	<input type="checkbox"/> NA
Review Test Report according FGW TG4.	See point 1.3 of this document	<input checked="" type="checkbox"/> P	<input type="checkbox"/> NC	<input type="checkbox"/> NA
Quality system certificate according ISO 9001	See point 1.4 of this document	<input checked="" type="checkbox"/> P	<input type="checkbox"/> NC	<input type="checkbox"/> NA
Compromise letter of maintain ISO 9001 certified during the validity period of VDE certificate.	See point 1.5 of this document	<input checked="" type="checkbox"/> P	<input type="checkbox"/> NC	<input type="checkbox"/> NA
Compromise letter of product to certify is the same that the product tested, and transferability acceptance of non-tested PGU.	See point 1.6 of this document	<input checked="" type="checkbox"/> P	<input type="checkbox"/> NC	<input type="checkbox"/> NA

1.1 Information about the tested model.

Information appearing in the application form (CPR1FRM5):

- **Date of the application form:** 21/01/2020
- **Applicant:** Sungrow Power Supply Co., Ltd
- **License holder:** Sungrow Power Supply Co., Ltd
- **Factories:**
 1. Sungrow Power Supply Co., Ltd
Address: No.1699 Xiyou Rd.,New & High Technology Industrial Development Zone, Hefei 230088 P.R. China
 2. Sungrow Power Supply Co., Ltd.
Address: No. 608 Changning Avenue, New & High Technology Industrial Development Zone, Hefei 230088 P.R. China.
 3. Sungrow Developers (India) Private Limited.
Address: No. 85, Kaniminike village, Kengeri hobli Bangalore South Taluk, 560074 Bangalore, India
- **Product:**
 - Type: PV inverter
 - Trademark: Sungrow
 - Base model: SG110CX
 - Input ratings: 1100 Vdc,max (200-1000 Vdc,MPPT); 9*26 Adc Max
 - Output ratings: 3~ 400Vac; 50 Hz; 158.8Aac Max.; 100kW (110kVA Max).
 - Software Version: LCD_AMBER-S_V11_V01_A, MDSP_AMBER-S_V11_V01_A
 - Variant models: None

Information appearing in the test report according to FGW TG3:

- **Manufacturer:** SUNGROW POWER SUPPLY CO., LTD
- **Product:**
 - Type: Three phase grid connected PV inverter
 - Trademark: SUNGROW
 - Base model: SG110CX
 - Input ratings: 1100 Vdc max (200-1000 Vdc,MPPT); 9*26 Adc Max
 - Output ratings: 3~ 400Vac; 50 Hz; 158,8 Aac Max.; 144,4 Aac Rated, 100kW (110kVA Max).
 - Software Version: LCD_AMBER-S_V11_V01_A; MDSP_AMBER-S_V11_V01_A
 - Serial number: A1905240811
 - Variant models: --

Revision 1 dated 14th July 2020.

The manufacturer provides a new application form dated on 14/07/2020 requesting to modify the certificate in order to add into its scope the rating of the maximum apparent power of the previously certified PV inverter. New tests are repeated in the certified unit to verify these maximum power capabilities.

The manufacturer assures in the application form that the certified product is not been varied in hardware, nor firmware since tests performed for the original certification, so not repeated tests can still be valid.

In addition, the manufacturer asks to update the annex of the certification to add editorial changes. For this reason, a new manufacturer declaration related with the certified product has been provided.

Information appearing in the application form (CPR1FRM5):

- **Date of the application form:** 14/07/2020
- **Applicant:** Sungrow Power Supply Co., Ltd
- **License holder:** Sungrow Power Supply Co., Ltd
- **Factories:**
 1. Sungrow Power Supply Co., Ltd
Address: No.1699 Xiyou Rd.,New & High Technology Industrial Development Zone, Hefei 230088 P.R. China
 2. Sungrow Power Supply Co., Ltd.
Address: No. 608 Changning Avenue, New & High Technology Industrial Development Zone, Hefei 230088 P.R. China.
 3. Sungrow Developers (India) Private Limited.
Address: No. 85, Kaniminike village, Kengeri hobli Bangalore South Taluk, 560074 Bangalore, India
- **Product:**
 - Type: PV inverter
 - Trademark: Sungrow
 - Base model: SG110CX
 - Input ratings: 1100 Vdc,max (200-1000 Vdc,MPPT); 9*26 Adc Max
 - Output ratings: 3~ 400Vac; 50 Hz; 158,8Aac Max.; 100kW (110kVA Max).
 - Software Version: LCD_AMBER-S_V11_V01_A, MDSP_AMBER-S_V11_V01_A
 - Variant models: None

Information appearing in the test report according to FGW TG3:

- **Manufacturer:** SUNGROW POWER SUPPLY CO., LTD
- **Product:**
 - Type: Three phase grid connected PV inverter
 - Trademark: SUNGROW
 - Base model: SG110CX
 - Input ratings: 1100 Vdc max (200-1000 Vdc,MPPT); 9*26 Adc Max
 - Output ratings: 3~ 400Vac; 50 Hz; 158,8 Aac Max.; 144,4 Aac Rated, 100kW (110kVA Max).
 - Software Version: LCD_AMBER-S_V11_V01_A; MDSP_AMBER-S_V11_V01_A
 - Serial number: A1905240811
 - Variant models: --

Revision 2

A new application form is received on 16/12/2021 for the update of the certificate no. 2619/0375-E1-CER. The customer provides an Dynamic Simulation Model (version 3.0) with the following update:

- The negative sequence active power limit is added to the model to prevent the total current from exceeding the limit due to the output of negative sequence active current in case of some unbalanced faults

To prove that the updated Dynamic Simulation Model (version 3.0) does not show any critical change compared to the previous version used in the original report number 2219 / 0375 - TG4, few tests were repeated. For more details see clause 3.1.3 of this Annex to Certificate

Information appearing in the application form (CPR1FRM5):

- **Date of the application form:** 16/12/2021
- **Applicant:** Sungrow Power Supply Co., Ltd
- **License holder:** Sungrow Power Supply Co., Ltd
- **Factories:**
 4. Sungrow Power Supply Co., Ltd
Address: No.1699 Xiyou Rd.,New & High Technology Industrial Development Zone, Hefei 230088 P.R. China
 5. Sungrow Power Supply Co., Ltd.
Address: No. 608 Changning Avenue, New & High Technology Industrial Development Zone, Hefei 230088 P.R. China.
 6. Sungrow Developers (India) Private Limited.
Address: No. 85, Kaniminike village, Kengeri hobli Bangalore South Taluk, 560074 Bangalore, India
- **Product:**
 - Type: PV inverter
 - Trademark: Sungrow
 - Base model: SG110CX
 - Input ratings: 1100 Vdc,max (200-1000 Vdc,MPPT); 9*26 Adc Max
 - Output ratings: 3~ 400Vac; 50 Hz; 158.8Aac Max.; 100kW (110kVA Max).
 - Software Version: LCD_AMBER-S_V11_V01_A, MDSP_AMBER-S_V11_V01_A
 - Variant models: None

1.2 Summary of the evaluation of the test results

The following documentation is used for the evaluation:

Information of the test report:

- Test report number: 2219 / 0375 – E3
- Issuance date: 13/07/2020.
- Testing laboratory: SGS Tecnos, S.A. (Electrical Testing Laboratory).
- Accreditation number of the laboratory: N° 5/LE011.

Information of the manufacturer declaration:

- Document reference name: Declaration for SG110CX TR8 Rev_2
- Issuance date: 03/07/2020.
- Issued by: Sungrow Power Supply Co., Ltd.
- Signed by: Gatty Chen, Standard and Certification Engineer.

0 1 2 3 4 5



FGW TG8	Title				Result
A.1.2.1 A.2.2.1	Physical part				--
A.1.2.1.1 A.2.2.1.1	Dimensioning of the equipment at the substation				--
	Not applicable to PGU				NA
A.1.2.2 A.2.2.2	Operating range				P
A.1.2.2.1 A.2.2.2.1	Quasi-steady-state operation				--
A.1.2.2.1.1 A.2.2.2.1.1	VDE 4110 Requirement Cl.	VDE 4110 Verification Cl.	Associated documents	Requirement needed	P
	10.2.1.2	11.2.3.1 11.2.4 11.2.5.5	TG3	<input checked="" type="checkbox"/> Manufacturer's declaration <input checked="" type="checkbox"/> Test report	
	VDE 4120 Requirement Cl.	VDE 4120 Verification Cl.	Associated documents	Requirement needed	
	10.2.1.2	11.2.3.1 11.2.4 11.2.5.4	TG3	<input checked="" type="checkbox"/> Manufacturer's declaration <input checked="" type="checkbox"/> Test report	
<p>Evaluated documentation:</p> <ul style="list-style-type: none"> - Manufacturer declaration: "Declaration for SG110CX TR8 Rev_2". Dated on July 3rd, 2020. Compliance is evidenced by the information declared by the manufacturer in points 3.1.1 and 3.5.2 of this manufacturer declaration. "SG110CX PV inverter is able to work in parallel operation with grid according to the minimum duration time stated in Figure 4 of VDE standards." <p>Figure 4 – Minimum requirements for the quasi-static operation of power generating plants</p> <ul style="list-style-type: none"> - Test Report: Test report no. 2219 / 0375 – E3. Dated on July 13th, 2020. Compliance is evidenced by test results provided in points 4.2.1.5 and 4.7 of this test report. 					
A.1.2.2.2 A.2.2.2.2	Polar wheel and/or grid oscillation				--
A.1.2.2.2.1 A.2.2.2.2.1	VDE 4110 Requirement Cl.	VDE 4110 Verification Cl.	Associated documents	Requirement needed	NA
	10.2.1.3	11.2.3.2 11.2.3.3	--	<input type="checkbox"/> Manufacturer's declaration	
	VDE 4120 Requirement Cl.	VDE 4120 Verification Cl.	Associated documents	Requirement needed	
	10.2.1.3	11.2.3.2 11.2.3.3	--	<input type="checkbox"/> Manufacturer's declaration	
<p>Remarks: For Type 2 PGU no proof of polar wheel oscillations is required.</p>					

FGW TG8	Title				Result
A.1.2.3 A.2.2.3	System perturbations				P
A.1.2.3.1 A.2.2.3.1	Rapid voltage variations				--
A.1.2.3.1.1 A.2.2.3.1.1	VDE 4110 Requirement Cl.	VDE 4110 Verification Cl.	Associated documents	Requirement needed	P
	5.4.2	11.2.2.1	TG3	<input checked="" type="checkbox"/> Test report	
	VDE 4120 Requirement Cl.	VDE 4120 Verification Cl.	Associated documents	Requirement needed	
	5.4.2	11.2.2.1	TG3	<input checked="" type="checkbox"/> Test report	
	<u>Evaluated documentation:</u> - Test Report: Test report no. 2219 / 0375 – E3. Dated on July 13 th , 2020. Compliance is evidenced by test results provided in the point 4.3.1 of this test report.				
A.1.2.3.2 A.2.2.3.2.	Flicker				--
A.1.2.3.2.1 A.2.2.3.2.1	VDE 4110 Requirement Cl.	VDE 4110 Verification Cl.	Associated documents	Requirement needed	P
	5.4.3	11.2.2.2	TG3	<input checked="" type="checkbox"/> Test report	
	VDE 4120 Requirement Cl.	VDE 4120 Verification Cl.	Associated documents	Requirement needed	
	5.4.3	11.2.2.2	TG3	<input checked="" type="checkbox"/> Test report	
	<u>Evaluated documentation:</u> - Test Report: Test report no. 2219 / 0375 – E3. Dated on July 13 th , 2020. Compliance is evidenced by test results provided in the point 4.3.2 of this test report.				
A.1.2.3.3 A.2.2.3.3	Harmonics and Interharmonics				--
A.1.2.3.3.1 A.2.2.3.3.1	VDE 4110 Requirement Cl.	VDE 4110 Verification Cl.	Associated documents	Requirement needed	P
	5.4.4	11.2.2.3	TG3	<input checked="" type="checkbox"/> Test report	
	VDE 4120 Requirement Cl.	VDE 4120 Verification Cl.	Associated documents	Requirement needed	
	5.4.4	11.2.2.3	TG3	<input checked="" type="checkbox"/> Test report	
	<u>Evaluated documentation:</u> - Test Report: Test report no. 2219 / 0375 – E3. Dated on July 13 th , 2020. Compliance is evidenced by test results provided in the points 4.3.3.1 to 4.3.3.4 of this test report.				
A.1.2.3.4 A.2.2.3.4	Commutation notches				--
A.1.2.3.4.1 A.2.2.3.4.1	VDE 4110 Requirement Cl.	VDE 4110 Verification Cl.	Associated documents	Requirement needed	NA
	5.4.5	11.2.2.4	TG3	<input type="checkbox"/> Test report	
	VDE 4120 Requirement Cl.	VDE 4120 Verification Cl.	Associated documents	Requirement needed	
	5.4.5	11.2.2.4	TG3	<input type="checkbox"/> Test report	
	<u>Remarks:</u> Evidence only for converters with thyristors which use short-circuit current coming from the grid for commutation of the thyristors. The certified PV inverter doesn't have thyristors which use short-circuit current coming from the grid for commutation of the thyristors.				

FGW TG8	Title				Result
A.1.2.3 A.2.2.3	System perturbations				P
A.1.2.3.5 A.2.2.3.5	Asymmetries				--
A.1.2.3.5.1 A.2.2.3.5.1	VDE 4110 Requirement Cl.	VDE 4110 Verification Cl.	Associated documents	Requirement needed	P
	5.4.6	11.2.2.5	TG3	<input checked="" type="checkbox"/> Test report	
	VDE 4120 Requirement Cl.	VDE 4120 Verification Cl.	Associated documents	Requirement needed	
	5.4.6	11.2.2.5	TG3	<input checked="" type="checkbox"/> Test report	
	<u>Evaluated documentation:</u> - Test Report: Test report no. 2219 / 0375 – E3. Dated on July 13 th , 2020. Compliance is evidenced by test results provided in the point 4.3.4 of this test report.				
A.1.2.3.6 A.2.2.3.6	Audio frequency ripple control				--
	Not applicable to PGU				NA
A.1.2.3.7 A.2.2.3.7	Carrier frequency use of the customer grid				--
	Not applicable to PGU				NA
A.1.2.4 A.2.2.4	Reactive power				P
A.1.2.4.1 A.2.2.4.1	Reactive power provision				--
A.1.2.4.1.1 A.2.2.4.1.1	VDE 4110 Requirement Cl.	VDE 4110 Verification Cl.	Associated documents	Requirement needed	P
	10.2.2.1 to 10.2.2.3	11.2.4	TG3	<input checked="" type="checkbox"/> Manufacturer's declaration <input checked="" type="checkbox"/> Test report	
	VDE 4120 Requirement Cl.	VDE 4120 Verification Cl.	Associated documents	Requirement needed	
	10.2.2.1 to 10.2.2.3	11.2.4	TG3	<input checked="" type="checkbox"/> Manufacturer's declaration <input checked="" type="checkbox"/> Test report	
	<u>Evaluated documentation:</u> - Manufacturer declaration: "Declaration for SG110CX TR8 Rev_2". Dated on July 3 rd , 2020. Compliance is evidenced by the information declared by the manufacturer in point 3.2.2 of this manufacturer declaration. - Test Report: Test report no. 2219 / 0375 – E3. Dated on July 13 th , 2020. Compliance is evidenced by test results provided in points 4.2.1.1, 4.2.1.5, 4.2.2 and 4.2.4 of this test report.				
A.1.2.4.2 A.2.2.4.2	Procedure for reactive power provision				--
A.1.2.4.2.1 A.2.2.4.2.1	VDE 4110 Requirement Cl.	VDE 4110 Verification Cl.	Associated documents	Requirement needed	P
	10.2.2.4	--	TG3	<input checked="" type="checkbox"/> Manufacturer's declaration <input checked="" type="checkbox"/> Test report	
	VDE 4120 Requirement Cl.	VDE 4120 Verification Cl.	Associated documents	Requirement needed	
	10.2.2.4	--	TG3	<input checked="" type="checkbox"/> Manufacturer's declaration <input checked="" type="checkbox"/> Test report	
	<u>Evaluated documentation:</u> - Manufacturer declaration: "Declaration for SG110CX TR8 Rev_2". Dated on July 3 rd , 2020. Compliance is evidenced by the information declared by the manufacturer in point 3.2.2 of this manufacturer declaration. "In the strategy of reactive power control, follow reactive power is prioritised over the active power." "In the case of lost communication, the PV inverter will response to the latest reactive demand if have not preset reactive power in 'Communication interrupt configuration' in APP iSolarCloud." - Test Report: Test report no. 2219 / 0375 – E3. Dated on July 13 th 2020.				

FGW TG8	Title				Result
A.1.2.5 A.2.2.5	Active power				P
A.1.2.5.1 A.2.2.5.1	General information and grid safety management				--
A.1.2.5.1.1 A.2.2.5.1.1	VDE 4110 Requirement Cl.	VDE 4110 Verification Cl.	Associated documents	Requirement needed	P
	10.2.4.1 and 10.2.4.2	11.2.7	TG3	<input checked="" type="checkbox"/> Manufacturer's declaration <input checked="" type="checkbox"/> Test report	
	VDE 4120 Requirement Cl.	VDE 4120 Verification Cl.	Associated documents	Requirement needed	
	10.2.4.1 and 10.2.4.2	11.2.7	TG3	<input checked="" type="checkbox"/> Manufacturer's declaration <input checked="" type="checkbox"/> Test report	
	<u>Evaluated documentation:</u> - Manufacturer declaration: "Declaration for SG110CX TR8 Rev_2". Dated on July 3 rd , 2020. Compliance is evidenced by the information declared by the manufacturer in point 3.3.2 of this manufacturer declaration. - Test Report: Test report no. 2219 / 0375 – E3. Dated on July 13 th , 2020. Compliance is evidenced by test results provided in points 4.1.1 and 4.1.2.1 of this test report.				
A.1.2.5.2 A.2.2.5.2	Active power output as a function of grid frequency				--
A.1.2.5.2.1 A.2.2.5.2.1	VDE 4110 Requirement Cl.	VDE 4110 Verification Cl.	Associated documents	Requirement needed	P
	10.2.4.3	11.2.8	TG3	<input checked="" type="checkbox"/> Manufacturer's declaration <input checked="" type="checkbox"/> Test report	
	VDE 4120 Requirement Cl.	VDE 4120 Verification Cl.	Associated documents	Requirement needed	
	10.2.4.3	11.2.8	TG3	<input checked="" type="checkbox"/> Manufacturer's declaration <input checked="" type="checkbox"/> Test report	
	<u>Evaluated documentation:</u> - Manufacturer declaration: "Declaration for SG110CX TR8 Rev_2". Dated on July 3 rd , 2020. Compliance is evidenced by the information declared by the manufacturer in point 3.3.2 of this manufacturer declaration. - Test Report: Test report no. 2219 / 0375 – E3. Dated on July 13 th , 2020. Compliance is evidenced by test results provided in points 4.1.2 and 4.1.3 of this test report.				
A.1.2.6 A.2.2.6	Connection				--
A.1.2.6.1 A.2.2.6.1	Black start capability				--
	Not applicable to PGU				NA
A.1.2.6.2 A.2.2.6.2	Switching-in conditions				--
A.1.2.6.2.1 A.2.2.6.2.1	VDE 4110 Requirement Cl.	VDE 4110 Verification Cl.	Associated documents	Requirement needed	P
	10.4	11.2.11	TG 3	<input checked="" type="checkbox"/> Manufacturer's declaration <input checked="" type="checkbox"/> Test report	
	VDE 4120 Requirement Cl.	VDE 4120 Verification Cl.	Associated documents	Requirement needed	
	10.4	11.2.11	TG 3	<input checked="" type="checkbox"/> Manufacturer's declaration <input checked="" type="checkbox"/> Test report	
	<u>Evaluated documentation:</u> - Manufacturer declaration: "Declaration for SG110CX TR8 Rev_2". Dated on July 3 rd , 2020. Compliance is evidenced by the information declared by the manufacturer in point 3.4.1 of this manufacturer declaration. - Test Report: Test report no. 2219 / 0375 – E3. Dated on July 13 th , 2020. Compliance is evidenced by test results provided in points 4.1.4, 4.5.1 and 4.5.2 of this test report.				

FGW TG8	Title				Result
A.1.2.7 A.2.2.7	FRT				P
A.1.2.7.1 A.2.2.7.1	Loss of static stability				--
A.1.2.7.1.1 A.2.2.7.1.1	VDE 4110 Requirement Cl.	VDE 4110 Verification Cl.	Associated documents	Requirement needed	NA
	10.2.1.3 10.5.2	11.2.12	--	--	
	VDE 4120 Requirement Cl.	VDE 4120 Verification Cl.	Associated documents	Requirement needed	
	10.2.1.3 10.5.2	11.2.12	--	--	
	Remarks: No evidence necessary.				
A.1.2.7.2 A.2.2.7.2	Island and partial grid operation capability				--
A.1.2.7.2.1 A.2.2.7.2.1	VDE 4110 Requirement Cl.	VDE 4110 Verification Cl.	Associated documents	Requirement needed	NA
	10.2.1.4	--	--	<input checked="" type="checkbox"/> Manufacturer's declaration	
	VDE 4120 Requirement Cl.	VDE 4120 Verification Cl.	Associated documents	Requirement needed	
	10.2.1.4	--	--	<input checked="" type="checkbox"/> Manufacturer's declaration	
	Remarks: No requirements for island operation have been defined. Partial grid operation capability does not constitute a minimum requirement. The distribution grid operator may however require partial grid operation capability and the controller stability in individual cases. Only in this case do the following requirements apply. Here only optional characteristics of the PGU are shown, however not a declaration of conformity. <u>Evaluated documentation:</u> - Manufacturer declaration: "Declaration for SG110CX TR8 Rev_2". Dated on July 3 rd , 2020. Compliance is evidenced by the information declared by the manufacturer in point 3.5.1 of this manufacturer declaration. "SG110CX is not intend to use for Island operation and separate network operation"				
A.1.2.7.3 A.2.2.7.3	Dynamic grid support				--
A.1.2.7.3.1 A.2.2.7.3.1	VDE 4110 Requirement Cl.	VDE 4110 Verification Cl.	Associated documents	Requirement needed	P
	10.2.1.2 10.2.3	11.2.5	TG 3	<input checked="" type="checkbox"/> Manufacturer's declaration <input checked="" type="checkbox"/> Test report	
	VDE 4120 Requirement Cl.	VDE 4120 Verification Cl.	Associated documents	Requirement needed	
	10.2.1.2 10.2.3	11.2.5	TG 3	<input checked="" type="checkbox"/> Manufacturer's declaration <input checked="" type="checkbox"/> Test report	
	<u>Evaluated documentation:</u> - Manufacturer declaration: "Declaration for SG110CX TR8 Rev_2". Dated on July 3 rd , 2020. Compliance is evidenced by the information declared by the manufacturer in point 3.5.2 of this manufacturer declaration. - Test Report: Test report no. 2219 / 0375 – E3. Dated on July 13 th , 2020. Compliance is evidenced by test results provided in points 4.6 and 4.7 of this test report. The point 4.6 of the test report refers to the attachment I of the report: 2219 / 0375 ATTACHMENT I which includes calculations of short-circuit AC currents.				

FGW TG8	Title				Result
A.1.2.7 A.2.2.7	FRT				P
A.1.2.7.4 A.2.2.7.4	Contribution to short-circuit current				--
A.1.2.7.4.1 A.2.2.7.4.1	VDE 4110 Requirement Cl.	VDE 4110 Verification Cl.	Associated documents	Requirement needed	P
	10.2.5.2	11.2.9	TG 3	<input checked="" type="checkbox"/> Manufacturer's declaration <input checked="" type="checkbox"/> Test report	
	VDE 4120 Requirement Cl.	VDE 4120 Verification Cl.	Associated documents	Requirement needed	
	10.2.5.2	11.2.9	TG 3	<input checked="" type="checkbox"/> Manufacturer's declaration <input checked="" type="checkbox"/> Test report	
Evaluated documentation: - Manufacturer declaration: "Declaration for SG110CX TR8 Rev_2". Dated on July 3 rd , 2020. Compliance is evidenced by the information declared by the manufacturer in point 3.5.3 of this manufacturer declaration. - Test Report: Test report no. 2219 / 0375 – E3. Dated on July 13 th , 2020. Compliance is evidenced by test results provided in the point 4.6 of this test report. The point 4.6 of the test report refers to the attachment I of the report: 2219 / 0375 ATTACHMENT I which includes calculations of short-circuit AC currents.					
A.1.2.8 A.2.2.8	Protection				P
A.1.2.8.1 A.2.2.8.1	Reserve protection concept				--
	Not applicable to PGU				NA
A.1.2.8.2 A.2.2.8.2	Readability of protection settings				--
A.1.2.8.2.1 A.2.2.8.2.1	VDE 4110 Requirement Cl.	VDE 4110 Verification Cl.	Associated documents	Requirement needed	NA
	6.3.3	11.2.10	--	<input checked="" type="checkbox"/> Manufacturer's declaration <input type="checkbox"/> Or component certificate	
	VDE 4120 Requirement Cl.	VDE 4120 Verification Cl.	Associated documents	Requirement needed	
	6.3.3	11.2.10 11.4.17	--	<input checked="" type="checkbox"/> Manufacturer's declaration <input type="checkbox"/> Or component certificate	
Evaluated documentation: - Manufacturer declaration: "Declaration for SG110CX TR8 Rev_2". Dated on July 3 rd , 2020. Compliance is evidenced by the information declared by the manufacturer in point 3.6.1 of this manufacturer declaration. "SG110CX's protection setting can be easily read by the PV inverter setting APP and the protection setting list is shown as required in the standard of reference."					
A.1.2.8.3 A.2.2.8.3	Test terminal				--
A.1.2.8.3.1 A.2.2.8.3.1	VDE 4110 Requirement Cl.	VDE 4110 Verification Cl.	Associated documents	Requirement needed	NA
	6.3.4.5	11.2.10	--	<input checked="" type="checkbox"/> Manufacturer's declaration	
	VDE 4120 Requirement Cl.	VDE 4120 Verification Cl.	Associated documents	Requirement needed	
	6.3.3.5	11.2.10	--	<input checked="" type="checkbox"/> Manufacturer's declaration	
Evaluated documentation: - Manufacturer declaration: "Declaration for SG110CX TR8 Rev_2". Dated on July 3 rd , 2020. Compliance is evidenced by the information declared by the manufacturer in point 3.6.2 of this manufacturer declaration. "SG110CX don't provide testing terminal for protection test without disconnect the wires, such test terminal would be supplied at the system level on the LV side of MV transformer."					

FGW TG8	Title				Result
A.1.2.8 A.2.2.8	Protection				P
A.1.2.8.4 A.2.2.8.4	Operating range				--
A.1.2.8.4.1 A.2.2.8.4.1	VDE 4110 Requirement Cl.	VDE 4110 Verification Cl.	Associated documents	Requirement needed	P
	10.3.4.2.2	11.2.10	TG 3	<input checked="" type="checkbox"/> Manufacturer's declaration <input checked="" type="checkbox"/> Test report	
	VDE 4120 Requirement Cl.	VDE 4120 Verification Cl.	Associated documents	Requirement needed	
	10.3.4.7	11.2.10	TG 3	<input checked="" type="checkbox"/> Manufacturer's declaration <input checked="" type="checkbox"/> Test report	
Evaluated documentation: - Manufacturer declaration: "Declaration for SG110CX TR8 Rev_2". Dated on July 3 rd , 2020. Compliance is evidenced by the information declared by the manufacturer in point 3.6.3 of this manufacturer declaration. "There is no additional protection equipment present in SG110CX". - Test Report: Test report no. 2219 / 0375 – E3. Dated on July 13 th , 2020. Compliance is evidenced by test results provided in the point 4.4 of this test report.					
A.1.2.8.5 A.2.2.8.5	Voltage protection device and Q(U) protection				--
	Not applicable to PGU				NA
A.1.2.8.6 A.2.2.8.6	Accuracy				--
A.1.2.8.6.1 A.2.2.8.6.1	VDE 4110 Requirement Cl.	VDE 4110 Verification Cl.	Associated documents	Requirement needed	P
	10.3.3.2	11.2.10	TG 3	<input checked="" type="checkbox"/> Test report	
	VDE 4120 Requirement Cl.	VDE 4120 Verification Cl.	Associated documents	Requirement needed	
	10.2.4.3 10.3.4.2	11.2.10	TG 3	<input checked="" type="checkbox"/> Test report	
Evaluated documentation: - Test Report: Test report no. 2219 / 0375 – E3. Dated on July 13 th , 2020. Compliance is evidenced by test results provided in the point 4.4 of this test report.					
A.1.2.8.7 A.2.2.8.7	Independence of the protection functions				--
A.1.2.8.7.1 A.2.2.8.7.1	VDE 4110 Requirement Cl.	VDE 4110 Verification Cl.	Associated documents	Requirement needed	P
	10.3.3.1	11.2.10	--	<input checked="" type="checkbox"/> Manufacturer's declaration	
	VDE 4120 Requirement Cl.	VDE 4120 Verification Cl.	Associated documents	Requirement needed	
	10.3.3.1	11.2.10	--	<input checked="" type="checkbox"/> Manufacturer's declaration	
Evaluated documentation: - Manufacturer declaration: "Declaration for SG110CX TR8 Rev_2". Dated on July 3 rd , 2020. Compliance is evidenced by the information declared by the manufacturer in point 3.6.4 of this manufacturer declaration. "SG110CX inverter integrated self-protection function is independent of any control functions".					
A.1.2.8.8 A.2.2.8.8	Protection monitoring				--
	Not applicable to PGU				NA

FGW TG8	Title				Result
A.1.2.8 A.2.2.8	Protection				P
A.1.2.8.9 A.2.2.8.9	Own and auxiliary power supply				--
A.1.2.8.9.1 A.2.2.8.9.1	VDE 4110 Requirement Cl.	VDE 4110 Verification Cl.	Associated documents	Requirement needed	P
	10.3.3.6	11.2.10	TG 3	<input checked="" type="checkbox"/> Manufacturer's declaration <input type="checkbox"/> Component certificate	
	VDE 4120 Requirement Cl.	VDE 4120 Verification Cl.	Associated documents	Requirement needed	
	10.3.1	11.2.10	TG 3	<input checked="" type="checkbox"/> Manufacturer's declaration <input type="checkbox"/> Component certificate	
<u>Evaluated documentation:</u> - Manufacturer declaration: "Declaration for SG110CX TR8 Rev_2". Dated on July 3 rd , 2020. Compliance is evidenced by the information declared by the manufacturer in point 3.6.5 of this manufacturer declaration. <i>"SG110CX protection system is power supplied by DC side, it's Network-independent auxiliary power supply to the protection equipment for at least 5 seconds. Failure of the auxiliary power supply of the protection equipment or the equipment control, respectively, causes the power generation to be switched off without delay and triggering of the PGU's main switch. The protection equipment provided for meets the requirements for accuracy and setting ranges. (Voltage and current accuracy are ±1%, frequency accuracy is 0.01Hz) Operability of the protection functions shall be provided before the power generating units start feeding in power. Functionality of protection function in the normal frequency operating ranges(Figure 4) is starting from 45Hz up to 55Hz".</i>					
A.1.2.8.9.4	Fault logger				--
A.2.2.8.9.10	Not applicable to PGU				NA
A.1.2.8.10 A.2.2.8.11	Coupling switch				--
A.1.2.8.9.1 A.2.2.8.9.1	VDE 4110 Requirement Cl.	VDE 4110 Verification Cl.	Associated documents	Requirement needed	P
	10.3 10.4.5	--	--	<input checked="" type="checkbox"/> Manufacturer's declaration	
	VDE 4120 Requirement Cl.	VDE 4120 Verification Cl.	Associated documents	Requirement needed	
	10.3 10.4.5	--	--	<input checked="" type="checkbox"/> Manufacturer's declaration	
<u>Evaluated documentation:</u> - Manufacturer declaration: "Declaration for SG110CX TR8 Rev_2". Dated on July 3 rd , 2020. Compliance is evidenced by the information declared by the manufacturer in point 3.6.6 of this manufacturer declaration.					

1.3 Summary of the evaluation of the validation results

The following documentation is used for the evaluation:

Information of the test report:

- Test report number: 2219/0375-TG4
- Issuance date: 28/01/2020
- Issued by: SGS Tecnos, S.A. (Electrical Testing Laboratory)
- Simulation model name: Project for SG110CX.pfd
- Version of the simulation model: V6
- MD5 Checksum: 326DBE8E8653557F34370591C169F8D5
- Simulation platform: DigSilent PowerFactory
- Simulation platform version: V 15.2.9. The validation report doesn't cover upper version of Digsilent above V15.2.9.

Information of the user manual documentation of the dynamic simulation model:

- Document reference name: User Manual and Model Description of DiGSILENT PowerFactory Model of SG110CX PV Inverter
- Version: V2.0
- Issuance date: 30/01/2020
- Issued by: Sungrow Power Supply Co., Ltd.
-

Revision 2

Report Number: 2219 / 0375 / A - TG4 with date 2022-01-19.

The Dynamic Simulation Model used on this test report is updated with the following modification

- The negative sequence active power limit is added to the model to prevent the total current from exceeding the limit due to the output of negative sequence active current in case of some unbalanced faults

Report Number: 2219 / 0375 / A - TG4 demonstrates that the updated Dynamic Simulation Model (version 3.0) does not show any critical change compared to the previous version used in the original report number 2219 / 0375 - TG4

Software Characteristics used on Report 2219 / 0375 / A - TG4

- Software type: Simulator for Grid Connected Power Conversion System
- Simulation platform: Digsilent Power Factory 2021 SP4B
- Used version of the simulation platform: Version 21.0.6.0 (*)
- Simulation Software File identification: VDE_SG110CX_PF2019.pfd
- Dynamic Simulation Model version: V3.0
- MD5 Checksum: 3FCC9FA23AE8972266BE9028106FE02A

(*) Simulation results offered in the validation report were obtained with the Powerfactory Digsilent Version 21.0.6.0. The validation report doesn't cover upper version of Digsilent above Version 21.0.6.0.

Information of the user manual documentation of the dynamic simulation model:

- Document reference name: User Manual and Model Description of DiGSILENT PowerFactory Model of SG110CX PV Inverter
- Version: V3.0
- Issuance date: 03/13/2021
- Issued by: Sungrow Power Supply Co., Ltd.

Revision 3

Report Number: 2219 / 0375 / A – E1 - TG4 contains the updated MD5 Checksum reference due to a typo in previous MD5 Checksum reference.

The dynamic simulation model itself has not changed, therefore no further testing is required.

Software Characteristics used on Report 2219 / 0375/ A – E1 - TG4

- Software type: Simulator for Grid Connected Power Conversion System
- Simulation platform: Digsilent Power Factory 2021 SP4B
- Used version of the simulation platform: Version 21.0.6.0 (*)
- Simulation Software File identification: VDE_SG110CX_PF2019.pfd
- Dynamic Simulation Model version: V3.0
- MD5 Checksum: 03383A92CB1A1C003CA3A000C295CB6B

(*) Simulation results offered in the validation report were obtained with the Powerfactory Digsilent Version 21.0.6.0. The validation report doesn't cover upper version of Digsilent above Version 21.0.6.0.

Information of the user manual documentation of the dynamic simulation model:

- Document reference name: User Manual and Model Description of DIgSILENT PowerFactory Model of SG110CX PV Inverter
- Version: V3.0
- Issuance date: 03/13/2021
- Issued by: Sungrow Power Supply Co., Ltd.

FGW TG8	Title				Result
A.1.2.9 A.2.2.9	Simulation models				P
A.1.2.9.1 A.2.2.9.1	Requirements for simulation models				--
A.1.2.9.1.1 A.2.2.9.1.1	VDE 4110 Requirement Cl.	VDE 4110 Verification Cl.	Associated documents	Requirement needed	P
	10.6	11.2.6	TG4	<input checked="" type="checkbox"/> Validated model <input checked="" type="checkbox"/> Validation report <input checked="" type="checkbox"/> Model documentation	
	VDE 4120 Requirement Cl.	VDE 4120 Verification Cl.	Associated documents	Requirement needed	
	10.6	11.2.6	TG4	<input checked="" type="checkbox"/> Validated model <input checked="" type="checkbox"/> Validation report <input checked="" type="checkbox"/> Model documentation	
Evaluated documentation: - Model Documentation: "User Manual and Model Description of DlgSILENT PowerFactory Model of SG110CX PV Inverter". Version3.0 dated on December 03 rd , 2022. - Validation Report: Test report no. 2219 / 0375 – A – E1 - TG4. Dated on February 09 th , 2022.					

0 1 2 3 4 5



Certificate CN15/21022.00, continued

Sungrow Power Supply Co., Ltd.

ISO 9001:2015

Issue 7.

Detailed scope

Design, development and manufacture of PV (photovoltaic) inverters, wind power converters, data logger, wireless communication module, smart communication box, storage inverters
Manufacture of PV (photovoltaic) inverters, wind power converters, data logger, wireless communication module, smart communication box, storage inverters.
Design, development and manufacture of storage inverters, ESS (energy storage system).
Design and manufacture of electrical drive motor controllers.
Design, development and manufacture of lithium ion storage system battery pack for electric power facilities.

Additional facilities

Sungrow Power Supply Co., Ltd.

Business Registration Address: No. 1699, Xiyou Road, New & High Technology Industrial Development Zone, Hefei City, P.R. China

Business Operation Address: No. 608, Changning Avenue, New & High Technology Industrial Development Zone, He Fei City, Anhui Province, P.R. China

Sungrow-Samsung SDI Energy Storage Power Supply Co., Ltd.

Business Registration Address: No. 788, Mingchuan Road, Boyan Science & Technology Park, New & High Technology Industrial Development Zone, Hefei City, P.R. China

Business Operation Address: No. 788, Mingchuan Road, Boyan Science & Technology Park, New & High Technology Industrial Development Zone, He Fei City, Anhui Province, P.R. China

HeFei E-Power Technology Co., Ltd.

Business Registration Address: Building 2#, No. 88, Wutong Road, New & High Technology Industrial Development Zone, Hefei City, P.R. China

Business Operation Address: Building 2#, No. 88, Wutong Road, New & High Technology Industrial Development Zone, He Fei City, Anhui Province, P.R. China



Page 2 of 3

This document is issued by the Company subject to its General Conditions of Certification Services accessible at www.sgs.com/terms_and_conditions.htm. Attention is drawn to the limitations of liability, indemnification and jurisdictional issues established therein. The authenticity of this document may be verified at <http://www.sgs.com/en/verified-clients-and-products/verified-clients-directory>. Any unauthorized alteration, forgery or falsification of the content or appearance of this document is unlawful and offenders may be prosecuted to the fullest extent of the law.

- 3. Sungrow Developers (India) Private Limited.
Address: No. 85, Kaniminike village, Kengeri hobli Bangalore South Taluk, 560074 Bangalore, India
Evidence: Certificate IN18/05814. Issued by SGS (UKAS accredited). Valid until 11th May 2024.



1.5 Compromise letter to maintain ISO 9001 during the validity period of certificate

Compromise letter

We Sungrow Power Supply Co., Ltd.

Declare the maintenance of the quality system certified by a certification accredited company, according to the requirements of ISO 9001:2015, during the validity period of the certificate, at least 5 years.

We are also committed to require our assemblers to comply with the same standards of quality during that period.

Brand: SUNGROW

Model: SG110CX

Date: 21th Jan, 2020

Name: Gatty Chen
Charge: Standard and Certification Engineer
Signature: *Gatty Chen*

1.6 Compromise letter of the certified product.

Product declaration

We **Sungrow Power Supply Co., Ltd.**

Declare that the product,

- SG110CX

tested by the SGS Tecnos E&E Laboratory Testing, according to the standards,

- VDE-AR-N 4110:2018...
- VDE-AR-N 4120:2018
- FGW TR3 according to test report 2219 / 0375 - E2.
- FGW TR4 according to validation report 2219 / 0375 - TG4.
- FGW TR8

are the same to the model to certify according to above-mentioned standards.

Date: 21th Jan. 2020

Name: Gatty Chen
Charge: Standard and Certification Engineer
Signature:



Note: the declaration is updated again after tests repeated for the issuance of the Revision 1 of the certificate.

Product declaration

We Sungrow Power Supply Co., Ltd.

Declare that the product,

- SG110CX

tested by the SGS Tecnos E&E Laboratory Testing, according to the standards,

- VDE-AR-N 4110:2018
- VDE-AR-N 4120:2018
- FGW TR3 according to test report 2219/0375-E3
- FGW TR4 according to validation report 2219/0375-TG4
- FGW TR8

are the same to the model to certify according to above-mentioned standards.

Date: 14th July, 2020

Name: Gatty Chen
Charge: Standard and Certification Engine
Signature:



2 OVERVIEW OF RESULTS OF THE FGW TR3 TEST REPORT

Test Report Number: 2219 / 0375 – E3 with date 13-07-2020 according of FGW TR3 rev. 25

2.1 Nenndaten / Rated data:

Nennscheinleistung S_n	100 kVA	Nennstrom I_n	144,4 A
Nennfrequenz f_n rated frequency f_n	50 Hz	Nennspannung U_n rated Voltage U_n	400 V

Note: The maximum apparent power of the certified unit is 110 kVA.

2.2 Power quality

2.2.1 Wirkleistungsspitzen / Power Peaks

DC Voltage (V)	Wirkleistungsspitzen in kW / Power peaks in kW		Wirkleistungsspitzen in p.u. / Power peaks in p.u.		Anzahl 10-Minuten Datensätze in / Number of 10-minute data set
551	$p_{600} = P_{600}/P_n$	100,267	$p_{60} = P_{60}/P_n$	1,003	9
591	$p_{600} = P_{600}/P_n$	109,701	$p_{60} = P_{60}/P_n$	1,097	9
631	$p_{600} = P_{600}/P_n$	109,472	$p_{60} = P_{60}/P_n$	1,095	9
671	$p_{600} = P_{600}/P_n$	109,576	$p_{60} = P_{60}/P_n$	1,096	9
710	$p_{600} = P_{600}/P_n$	109,864	$p_{60} = P_{60}/P_n$	1,099	9
751	$p_{600} = P_{600}/P_n$	109,857	$p_{60} = P_{60}/P_n$	1,099	9
791	$p_{600} = P_{600}/P_n$	109,852	$p_{60} = P_{60}/P_n$	1,099	9
831	$p_{600} = P_{600}/P_n$	109,703	$p_{60} = P_{60}/P_n$	1,097	9
851	$p_{600} = P_{600}/P_n$	99,601	$p_{60} = P_{60}/P_n$	1,000	9

Note: The MPPT range at nominal power (100kW) is from 550V to 850V. And the MPPT range at maximum power (110 kVA) is from 590V to 830V.

2.2.2 Schalthandlungen / Switching Operation

Schalthandlungen / Case of switching operation	Einschalten bei $P_{\text{verfügbar}} < 10\% P_n$ (Einschaltwindgeschw.) / Start-up at $P_{\text{available}} < 10\% P_n$ (cut-in wind speed)			
Max Anz. Schalthandlungen / Max, number of switching operations, N_{10}	20			
Max Anz. Schalthandlungen / Max, number of switching operations, N_{120}	240			
Netzimpedanzwinkel / Grid impedance angle	30°	50°	70°	85°
Flickerformfaktor / Flicker step factor, $k_f (\Psi_k)$	0,07	0,06	0,05	0,04
Spannungsänderungsfaktor / Voltage change factor, $k_U (\Psi_k)$	0,05	0,04	0,03	0,02

Schalthandlungen / Case of switching operation	Einschalten bei $P_{\text{verfügbar}} = P_n$ (Nennwindgeschwindigkeit) Start-up at $P_{\text{available}} = P_n$ (rated wind speed)			
Max Anz. Schalthandlungen / Max, number of switching operations, N_{10}	20			
Max Anz. Schalthandlungen / Max, number of switching operations, N_{120}	240			
Netzimpedanzwinkel / Grid impedance angle	30°	50°	70°	85°
Flickerformfaktor / Flicker step factor, $k_f (\Psi_k)$	0,81	0,61	0,35	0,15
Spannungsänderungsfaktor / Voltage change factor, $k_U (\Psi_k)$	0,06	0,05	0,03	0,03

Schalthandlungen / Case of switching operation	Serviceabschaltung bei Nennleistung / Cut off at rated power			
Max Anz. Schalthandlungen / Max, number of switching operations, N_{10}	10			
Max Anz. Schalthandlungen / Max, number of switching operations, N_{120}	120			
Netzimpedanzwinkel / Grid impedance angle	30°	50°	70°	85°
Flickerformfaktor / Flicker step factor, $k_f (\Psi_k)$	0,81	0,61	0,34	0,15
Spannungsänderungsfaktor / Voltage change factor, $k_U (\Psi_k)$	0,20	0,15	0,09	0,06

2.2.3 Unsymmetrie / Unbalances

P_n (%Sn)	P Measured (kW)	V_{1+} (V)	V_{1-} (V)	I_{1+} (A)	I_{1-} (A)	U_i (%)	Number of records
0	0,011	398,5	0,2	0,3	0,0	0,403	1
10	10,591	398,7	0,2	15,3	-0,1	0,719	1
20	20,717	398,7	0,2	30,0	-0,1	0,365	1
30	30,831	398,8	0,3	44,6	-0,1	0,306	1
40	40,946	398,9	0,3	59,3	-0,2	0,312	1
50	51,538	398,9	0,3	74,6	-0,2	0,274	1
60	61,623	399,0	0,3	89,2	-0,2	0,275	1
70	71,692	399,0	0,3	103,7	-0,2	0,240	1
80	82,092	399,1	0,3	118,8	-0,3	0,214	1
90	92,152	399,1	0,3	133,3	-0,3	0,220	1
100	101,989	399,2	0,3	147,5	-0,2	0,160	1
110	109,281	399,5	0,1	157,9	0,8	0,508	1

2.2.4 Flicker

Netzimpedanzwinkel / Network impedance phase angle, Ψ_k	30°	50°	70°	85°
P (%Pn)	Flickerkoeffizient / Flicker coefficient, C (Ψ_k , Pa)			
0	0,52	0,43	0,30	0,23
10	0,21	0,19	0,18	0,18
20	0,20	0,19	0,18	0,18
30	0,20	0,19	0,18	0,18
40	0,20	0,19	0,18	0,17
50	0,20	0,19	0,18	0,18
60	0,20	0,19	0,18	0,18
70	0,20	0,19	0,18	0,18
80	0,22	0,20	0,19	0,18
90	0,21	0,19	0,19	0,19
100	0,21	0,20	0,19	0,19
110	0,21	0,20	0,19	0,20
Max	0,52	0,43	0,30	0,23

2.2.5 Oberschwingungsmessungen / Harmonics

P _n (%)	0	10	20	30	40	50	60	70	80	90	100	110	Max (%)
	Nr./ Order	I _h (%)	I _h (%)	I _h (%)	I _h (%)	I _h (%)	I _h (%)	I _h (%)	I _h (%)	I _h (%)	I _h (%)	I _h (%)	
2	0,030	0,050	0,070	0,090	0,080	0,090	0,090	0,090	0,090	0,090	0,080	0,110	0,090
3	0,190	0,240	0,250	0,190	0,190	0,210	0,220	0,200	0,200	0,200	0,190	0,220	0,250
4	0,040	0,080	0,050	0,070	0,060	0,050	0,050	0,050	0,040	0,040	0,040	0,040	0,080
5	0,930	1,110	0,850	0,770	0,720	0,660	0,640	0,620	0,610	0,520	0,490	0,470	1,110
6	0,030	0,040	0,020	0,040	0,040	0,030	0,030	0,030	0,020	0,030	0,040	0,220	0,040
7	0,520	0,530	0,590	0,540	0,490	0,430	0,400	0,400	0,410	0,380	0,410	0,470	0,590
8	0,020	0,040	0,040	0,030	0,030	0,030	0,030	0,030	0,040	0,050	0,050	0,040	0,050
9	0,070	0,070	0,110	0,100	0,100	0,090	0,090	0,090	0,090	0,110	0,120	0,110	0,120
10	0,020	0,020	0,030	0,020	0,020	0,020	0,030	0,030	0,030	0,030	0,030	0,030	0,030
11	0,190	0,260	0,300	0,250	0,250	0,220	0,190	0,190	0,160	0,120	0,100	0,100	0,300
12	0,020	0,020	0,020	0,020	0,020	0,020	0,020	0,020	0,020	0,040	0,050	0,110	0,050
13	0,130	0,150	0,180	0,170	0,170	0,140	0,120	0,120	0,100	0,080	0,100	0,090	0,180
14	0,010	0,020	0,020	0,020	0,020	0,020	0,020	0,020	0,020	0,020	0,020	0,030	0,020
15	0,030	0,040	0,040	0,040	0,040	0,040	0,040	0,030	0,030	0,030	0,030	0,030	0,040
16	0,010	0,010	0,010	0,010	0,010	0,010	0,010	0,010	0,020	0,020	0,020	0,020	0,020
17	0,070	0,120	0,110	0,090	0,090	0,070	0,070	0,060	0,040	0,030	0,030	0,040	0,120
18	0,010	0,010	0,010	0,010	0,010	0,010	0,010	0,010	0,020	0,030	0,030	0,020	0,030
19	0,060	0,080	0,080	0,070	0,070	0,060	0,050	0,060	0,070	0,070	0,030	0,020	0,080
20	0,010	0,010	0,020	0,020	0,030	0,030	0,020	0,040	0,100	0,090	0,020	0,020	0,100
21	0,030	0,030	0,040	0,040	0,040	0,030	0,030	0,040	0,070	0,070	0,030	0,040	0,070
22	0,020	0,020	0,010	0,020	0,020	0,010	0,010	0,010	0,010	0,020	0,020	0,040	0,020
23	0,050	0,070	0,050	0,040	0,040	0,040	0,030	0,030	0,030	0,040	0,040	0,060	0,070
24	0,010	0,010	0,010	0,010	0,010	0,010	0,010	0,010	0,020	0,010	0,020	0,050	0,020
25	0,050	0,060	0,050	0,040	0,030	0,030	0,030	0,030	0,020	0,030	0,030	0,040	0,060
26	0,010	0,010	0,010	0,010	0,010	0,010	0,010	0,010	0,010	0,010	0,010	0,020	0,010
27	0,030	0,030	0,030	0,030	0,030	0,020	0,020	0,020	0,020	0,020	0,020	0,020	0,030
28	0,010	0,010	0,010	0,010	0,010	0,010	0,010	0,010	0,010	0,010	0,010	0,010	0,010
29	0,040	0,040	0,040	0,040	0,030	0,030	0,030	0,030	0,020	0,020	0,020	0,020	0,040
30	0,010	0,010	0,010	0,010	0,010	0,010	0,010	0,010	0,010	0,010	0,010	0,010	0,010
31	0,030	0,030	0,030	0,030	0,020	0,020	0,020	0,020	0,020	0,010	0,020	0,020	0,030
32	0,010	0,010	0,010	0,010	0,010	0,010	0,010	0,010	0,010	0,010	0,010	0,010	0,010
33	0,020	0,020	0,020	0,020	0,020	0,020	0,020	0,020	0,020	0,020	0,020	0,020	0,020
34	0,010	0,010	0,020	0,020	0,020	0,020	0,020	0,020	0,020	0,020	0,020	0,020	0,020
35	0,030	0,030	0,040	0,030	0,030	0,030	0,030	0,030	0,020	0,020	0,020	0,020	0,040
36	0,010	0,010	0,010	0,010	0,010	0,010	0,010	0,010	0,010	0,010	0,010	0,010	0,010
37	0,020	0,020	0,030	0,020	0,020	0,010	0,020	0,020	0,020	0,010	0,020	0,020	0,030
38	0,010	0,010	0,010	0,010	0,010	0,010	0,020	0,010	0,010	0,010	0,010	0,010	0,020
39	0,020	0,020	0,020	0,030	0,030	0,030	0,030	0,020	0,030	0,030	0,020	0,020	0,030
40	0,020	0,020	0,030	0,020	0,030	0,030	0,030	0,030	0,030	0,030	0,040	0,030	0,040
41	0,020	0,020	0,030	0,030	0,030	0,020	0,020	0,020	0,030	0,030	0,030	0,020	0,030
42	0,010	0,010	0,010	0,020	0,020	0,010	0,010	0,010	0,010	0,010	0,030	0,010	0,030
43	0,010	0,020	0,020	0,020	0,020	0,010	0,010	0,010	0,010	0,010	0,010	0,020	0,020
44	0,010	0,010	0,010	0,010	0,010	0,010	0,010	0,010	0,010	0,010	0,010	0,010	0,010
45	0,020	0,020	0,020	0,020	0,020	0,020	0,020	0,020	0,020	0,020	0,020	0,020	0,020
46	0,020	0,020	0,020	0,020	0,020	0,020	0,020	0,020	0,020	0,020	0,020	0,020	0,020
47	0,020	0,010	0,020	0,020	0,020	0,020	0,020	0,020	0,020	0,010	0,010	0,020	0,020
48	0,010	0,010	0,010	0,010	0,010	0,010	0,010	0,010	0,010	0,010	0,010	0,020	0,010
49	0,010	0,010	0,010	0,010	0,010	0,010	0,010	0,020	0,020	0,010	0,010	0,020	0,020
50	0,010	0,010	0,010	0,010	0,010	0,010	0,010	0,010	0,010	0,010	0,010	0,010	0,010
TDC (%)	1,122	1,312	1,148	1,034	0,970	0,882	0,844	0,824	0,819	0,731	0,715	0,788	1,312

2.2.6 Zwischenharmonische / Interharmonics

SG110CX													
P _n (%)	0	10	20	30	40	50	60	70	80	90	100	110	Max (%)
Nr./ Order	I _h (%)	I _h (%)	I _h (%)	I _h (%)	I _h (%)	I _h (%)	I _h (%)	I _h (%)	I _h (%)	I _h (%)	I _h (%)	I _h (%)	I _h (%)
75	0,02	0,02	0,02	0,02	0,02	0,02	0,02	0,02	0,02	0,03	0,03	0,03	0,03
125	0,02	0,02	0,02	0,02	0,02	0,02	0,02	0,02	0,02	0,02	0,02	0,02	0,02
175	0,02	0,02	0,02	0,02	0,02	0,02	0,02	0,02	0,02	0,03	0,03	0,03	0,03
225	0,02	0,02	0,02	0,02	0,02	0,02	0,02	0,02	0,02	0,03	0,03	0,02	0,03
275	0,02	0,02	0,02	0,02	0,02	0,02	0,02	0,02	0,02	0,02	0,03	0,02	0,03
325	0,02	0,02	0,02	0,02	0,02	0,02	0,02	0,02	0,02	0,03	0,03	0,02	0,03
375	0,02	0,02	0,02	0,02	0,02	0,02	0,02	0,02	0,02	0,03	0,03	0,03	0,03
425	0,02	0,02	0,02	0,02	0,02	0,02	0,02	0,02	0,02	0,03	0,03	0,03	0,03
475	0,02	0,02	0,02	0,02	0,02	0,02	0,02	0,02	0,02	0,03	0,03	0,03	0,03
525	0,02	0,02	0,02	0,02	0,02	0,02	0,02	0,02	0,02	0,02	0,02	0,03	0,03
575	0,02	0,02	0,02	0,02	0,02	0,02	0,02	0,02	0,02	0,03	0,03	0,03	0,03
625	0,02	0,02	0,02	0,02	0,02	0,02	0,02	0,02	0,02	0,03	0,03	0,03	0,03
675	0,09	0,10	0,11	0,11	0,12	0,13	0,13	0,14	0,14	0,16	0,16	0,14	0,16
725	0,02	0,02	0,02	0,02	0,02	0,02	0,02	0,02	0,02	0,02	0,02	0,02	0,02
775	0,02	0,02	0,02	0,02	0,02	0,02	0,02	0,02	0,02	0,02	0,03	0,02	0,03
825	0,01	0,02	0,02	0,02	0,02	0,02	0,02	0,02	0,02	0,02	0,02	0,02	0,02
875	0,02	0,02	0,02	0,02	0,02	0,02	0,02	0,02	0,02	0,02	0,02	0,02	0,02
925	0,01	0,01	0,02	0,02	0,02	0,05	0,07	0,07	0,06	0,02	0,02	0,02	0,07
975	0,02	0,02	0,03	0,02	0,03	0,07	0,10	0,10	0,08	0,08	0,14	0,02	0,14
1025	0,01	0,02	0,05	0,03	0,04	0,05	0,07	0,07	0,06	0,10	0,17	0,02	0,17
1075	0,03	0,03	0,03	0,04	0,04	0,02	0,02	0,02	0,02	0,07	0,13	0,06	0,13
1125	0,03	0,03	0,02	0,03	0,02	0,02	0,02	0,02	0,02	0,02	0,02	0,10	0,10
1175	0,04	0,03	0,03	0,03	0,03	0,03	0,03	0,03	0,03	0,03	0,03	0,11	0,11
1225	0,02	0,01	0,01	0,02	0,02	0,02	0,02	0,02	0,02	0,02	0,02	0,06	0,06
1275	0,03	0,02	0,02	0,02	0,02	0,02	0,02	0,02	0,02	0,02	0,02	0,04	0,04
1325	0,02	0,02	0,02	0,02	0,02	0,02	0,02	0,02	0,02	0,02	0,02	0,02	0,02
1375	0,04	0,01	0,02	0,02	0,02	0,02	0,02	0,02	0,02	0,02	0,02	0,02	0,04
1425	0,01	0,01	0,01	0,01	0,02	0,01	0,01	0,01	0,02	0,01	0,01	0,01	0,02
1475	0,02	0,02	0,02	0,02	0,03	0,03	0,03	0,03	0,03	0,03	0,03	0,02	0,03
1525	0,01	0,01	0,01	0,01	0,01	0,01	0,01	0,01	0,01	0,01	0,01	0,01	0,01
1575	0,02	0,01	0,01	0,01	0,01	0,01	0,01	0,01	0,01	0,01	0,01	0,01	0,02
1625	0,01	0,01	0,01	0,01	0,01	0,01	0,01	0,01	0,01	0,01	0,01	0,01	0,01
1675	0,01	0,01	0,01	0,01	0,01	0,01	0,01	0,01	0,01	0,01	0,01	0,01	0,01
1725	0,02	0,01	0,01	0,01	0,01	0,01	0,01	0,01	0,01	0,01	0,02	0,01	0,02
1775	0,01	0,01	0,01	0,01	0,01	0,01	0,01	0,01	0,01	0,01	0,01	0,01	0,01
1825	0,01	0,01	0,01	0,02	0,02	0,02	0,02	0,02	0,02	0,01	0,01	0,01	0,02
1875	0,01	0,01	0,01	0,01	0,01	0,01	0,01	0,01	0,01	0,01	0,02	0,01	0,02
1925	0,01	0,01	0,01	0,01	0,01	0,04	0,04	0,05	0,04	0,01	0,01	0,01	0,05
1975	0,01	0,01	0,03	0,01	0,02	0,05	0,04	0,05	0,04	0,04	0,02	0,01	0,05

2.2.7 Höhere Frequenzen / Higher Frequencies components

SG110CX													
P _n (%)	0	10	20	30	40	50	60	70	80	90	100	110	Max (%)
F (kHz)	I _h (%)	I _h (%)	I _h (%)	I _h (%)	I _h (%)	I _h (%)	I _h (%)	I _h (%)	I _h (%)	I _h (%)	I _h (%)	I _h (%)	I _h (%)
2,1	0,04	0,05	0,06	0,07	0,07	0,06	0,06	0,06	0,06	0,07	0,08	0,04	0,08
2,3	0,05	0,04	0,03	0,04	0,04	0,04	0,04	0,04	0,04	0,04	0,04	0,04	0,07
2,5	0,03	0,03	0,03	0,03	0,03	0,03	0,03	0,04	0,04	0,03	0,03	0,04	0,04
2,7	0,03	0,03	0,03	0,03	0,03	0,03	0,03	0,03	0,04	0,03	0,04	0,04	0,04
2,9	0,02	0,02	0,03	0,03	0,03	0,04	0,04	0,04	0,04	0,03	0,03	0,03	0,04
3,1	0,02	0,02	0,04	0,03	0,04	0,03	0,03	0,03	0,03	0,03	0,03	0,03	0,04
3,3	0,02	0,03	0,02	0,02	0,02	0,02	0,02	0,02	0,02	0,02	0,02	0,02	0,03
3,5	0,02	0,02	0,02	0,02	0,02	0,02	0,02	0,02	0,02	0,02	0,02	0,02	0,02
3,7	0,02	0,02	0,02	0,02	0,02	0,02	0,03	0,03	0,02	0,03	0,03	0,02	0,03
3,9	0,02	0,02	0,02	0,02	0,02	0,02	0,02	0,02	0,02	0,02	0,02	0,02	0,02
4,1	0,02	0,02	0,02	0,02	0,02	0,02	0,02	0,02	0,02	0,02	0,02	0,01	0,02
4,3	0,01	0,01	0,01	0,02	0,02	0,02	0,02	0,02	0,02	0,02	0,02	0,01	0,02
4,5	0,01	0,01	0,01	0,01	0,01	0,01	0,01	0,01	0,01	0,01	0,01	0,01	0,01
4,7	0,01	0,01	0,01	0,01	0,01	0,01	0,01	0,01	0,01	0,01	0,01	0,01	0,01
4,9	0,01	0,01	0,01	0,01	0,01	0,01	0,01	0,01	0,01	0,01	0,01	0,01	0,01
5,1	0,01	0,01	0,01	0,01	0,01	0,01	0,01	0,01	0,01	0,01	0,01	0,01	0,01
5,3	0,01	0,01	0,01	0,01	0,01	0,01	0,01	0,01	0,01	0,01	0,01	0,01	0,01
5,5	0,01	0,01	0,01	0,01	0,01	0,01	0,01	0,01	0,01	0,01	0,01	0,01	0,01
5,7	0,01	0,01	0,01	0,01	0,01	0,01	0,01	0,01	0,01	0,01	0,01	0,01	0,01
5,9	0,01	0,01	0,01	0,01	0,01	0,01	0,01	0,01	0,01	0,01	0,01	0,01	0,01
6,1	0,01	0,01	0,01	0,01	0,01	0,01	0,01	0,01	0,01	0,01	0,01	0,01	0,01
6,3	0,01	0,01	0,01	0,01	0,01	0,01	0,01	0,01	0,01	0,01	0,01	0,01	0,01
6,5	0,01	0,01	0,01	0,01	0,01	0,01	0,01	0,01	0,01	0,01	0,01	0,01	0,01
6,7	0,02	0,02	0,02	0,02	0,02	0,02	0,02	0,02	0,02	0,02	0,02	0,01	0,02
6,9	0,01	0,01	0,01	0,01	0,01	0,01	0,01	0,01	0,01	0,01	0,01	0,01	0,01
7,1	0,01	0,01	0,01	0,01	0,01	0,01	0,01	0,01	0,01	0,01	0,01	0,01	0,01
7,3	0,01	0,01	0,01	0,01	0,01	0,01	0,01	0,01	0,01	0,01	0,01	0,01	0,01
7,5	0,01	0,01	0,01	0,01	0,01	0,01	0,01	0,01	0,01	0,01	0,01	0,01	0,01
7,7	0,01	0,01	0,01	0,01	0,01	0,01	0,01	0,01	0,01	0,01	0,01	0,01	0,01
7,9	0,01	0,01	0,01	0,01	0,01	0,01	0,01	0,01	0,01	0,01	0,01	0,01	0,01
8,1	0,01	0,01	0,01	0,01	0,01	0,01	0,01	0,01	0,01	0,01	0,01	0,01	0,01
8,3	0,01	0,01	0,01	0,01	0,01	0,01	0,01	0,01	0,01	0,01	0,01	0,01	0,01
8,5	0,01	0,01	0,01	0,01	0,01	0,01	0,01	0,01	0,01	0,01	0,01	0,01	0,01
8,7	0,01	0,01	0,01	0,01	0,01	0,01	0,01	0,01	0,01	0,01	0,01	0,01	0,01
8,9	0,01	0,01	0,01	0,01	0,01	0,01	0,01	0,01	0,01	0,01	0,01	0,01	0,01

2.3 Grid Control Capability

2.3.1 Wirkleistungseinspeisung in Abhängigkeit der Netzfrequenz / Active power vs frequency

Überfrequenz / overfrequency	Mittlerer Gradient der Wirkleistung zum Zeitpunkt der Frequenzüberhöhung / Mean power gradient at overfrequency	mittl. Gradient / mean gradient 42,4 % P_M /Hz (Test with $P_M = 100,6$ %Pn) 38,5 % P_M /Hz (Test with $P_M = 50,5$ %Pn)	
	Max. Einschwingzeit / Max. Settling time	0,6 s (Test with $P_M = 100,6$ %Pn) 0,4 s (Test with $P_M = 50,5$ %Pn)	
	Gradient der Wirkleistung nach Rückkehr aus Überfrequenz / Power gradient after recovery of over frequency	mittl. Gradient / mean gradient 8,8 %Pn/Hz max. Gradient / max. gradient 8,8 %Pn/Hz (Test with $P_M = 50,5$ %Pn)	
Unterfrequenz / underfrequency	Mittlerer Gradient der Wirkleistung zum Zeitpunkt der Frequenzunterschreitung / Mean power gradient at underfrequency	mittl. Gradient / mean gradient 38,0 % P_M /Hz (Test with $P_M = 50,3$ %Pn) 41,0 % P_M /Hz (Test with $P_M = 25,6$ %Pn)	
	Max. Einschwingzeit / Max. Settling time	0,7 s (Test with $P_M = 50,3$ %Pn) 0,8 s (Test with $P_M = 25,6$ %Pn)	
	Gradient der Wirkleistung nach Rückkehr aus Unterfrequenz / Power gradient after recovery of under frequency	mittl. Gradient / mean gradient 8,8 %Pn/Hz max. Gradient / max. gradient 8,8 %Pn/Hz (Test with $P_M = 50,3$ %Pn) mittl. Gradient / mean gradient 8,7 %Pn/Hz max. Gradient / max. gradient 8,7 %Pn/Hz (Test with $P_M = 25,6$ %Pn)	
Die EZE kann mit reduzierter Leistung betrieben werden. / The unit is able to run at reduced power		<input checked="" type="checkbox"/> Ja / Yes	<input type="checkbox"/> Nein / No
Maximale Sollwertabweichung der Wirkleistung Max. deviation of power setting		Überschreitung / Exceeding 0,9 kW	Unterschreitung / Undercut 0.0 kW
Trennung vom Nets bei Wirkleistungssollwertvorgabe von: Disconnection from the grid at external active power setpoints at:		-- % Pn No disconnection is recorded. Operation at 0%Pn is evidenced.	
Einschwingzeit der Leistung für einen Sollwertsprung mit minimalem Gradienten / Response time of the power output after a change in setpoint with minimal gradient	P0 -> Pmin	Zeit / time : 47,6 s Gradient: 0,33 % Pn / s	
	Pmin -> P0	Zeit / time : 42,8 s Gradient: 0,33 % Pn / s	
Einschwingzeit der Leistung für einen Sollwertsprung mit maximalem Gradienten / Response time of the power output after a change in setpoint with maximum gradient	P0 -> Pmin	Zeit / time : 117,1 s Gradient: 0,71 % Pn / s	
	Pmin -> P0	Zeit / time : 115,5 s Gradient: 0,68 % Pn / s	

As stated in the Manufacturer Declaration for SG110CX (Rev 2, dated on July 3rd, 2020):

“Active power output is dependent on the temperature and mppt voltage according to the following curve.”

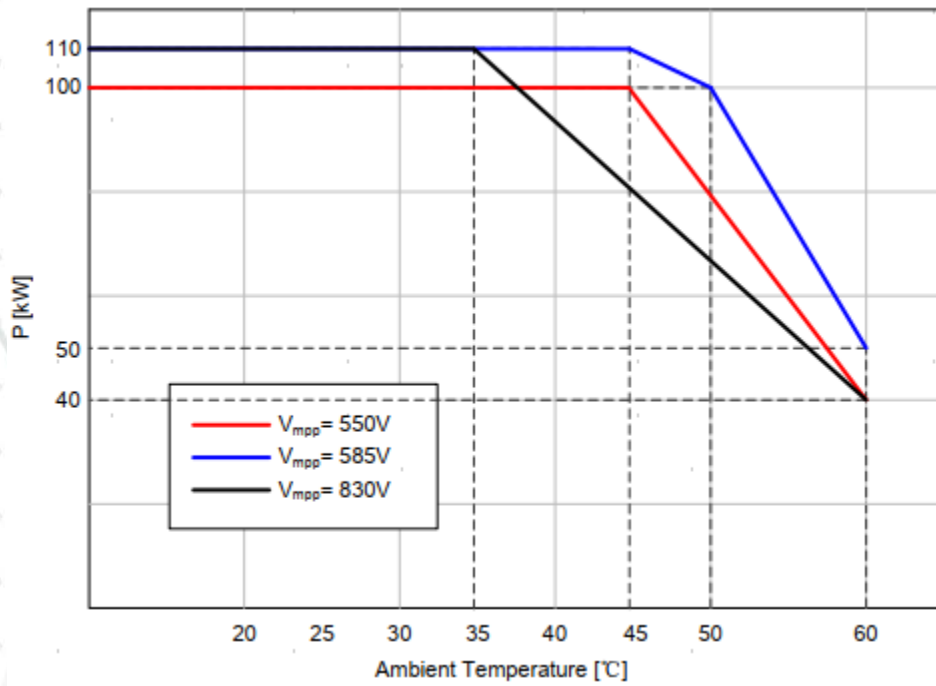

“Also, there is a dependency in Altitude according to the following curve.”

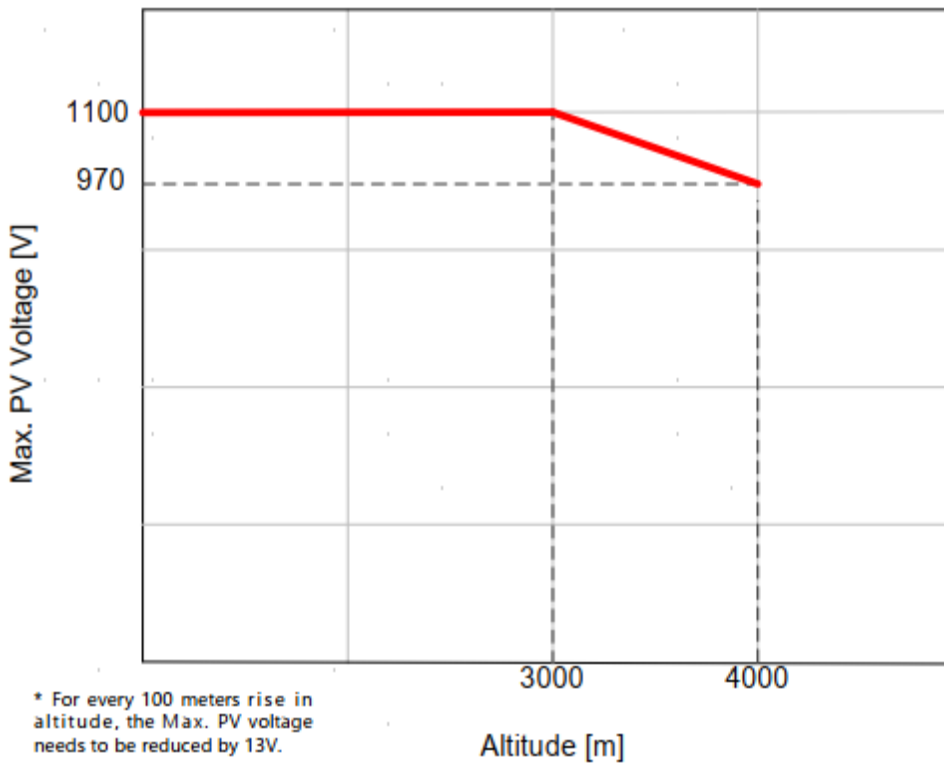

2.3.2 Procedure for reactive power provision

As stated in the Manufacturer Declaration for SG110CX (Rev 2, dated on July 3rd, 2020):

“In the strategy of reactive power control, follow reactive power is prioritised over the active power.”

“In the case of lost communication, the PV inverter will response to the latest reactive demand if have not preset reactive power in ‘Communication interrupt configuration’ in APP iSolarCloud.”

The certified PV inverter fulfils the following P-Q diagram at different voltage levels, as stated in the Manufacturer Declaration for SG110CX (Rev 2, dated on July 3rd, 2020):

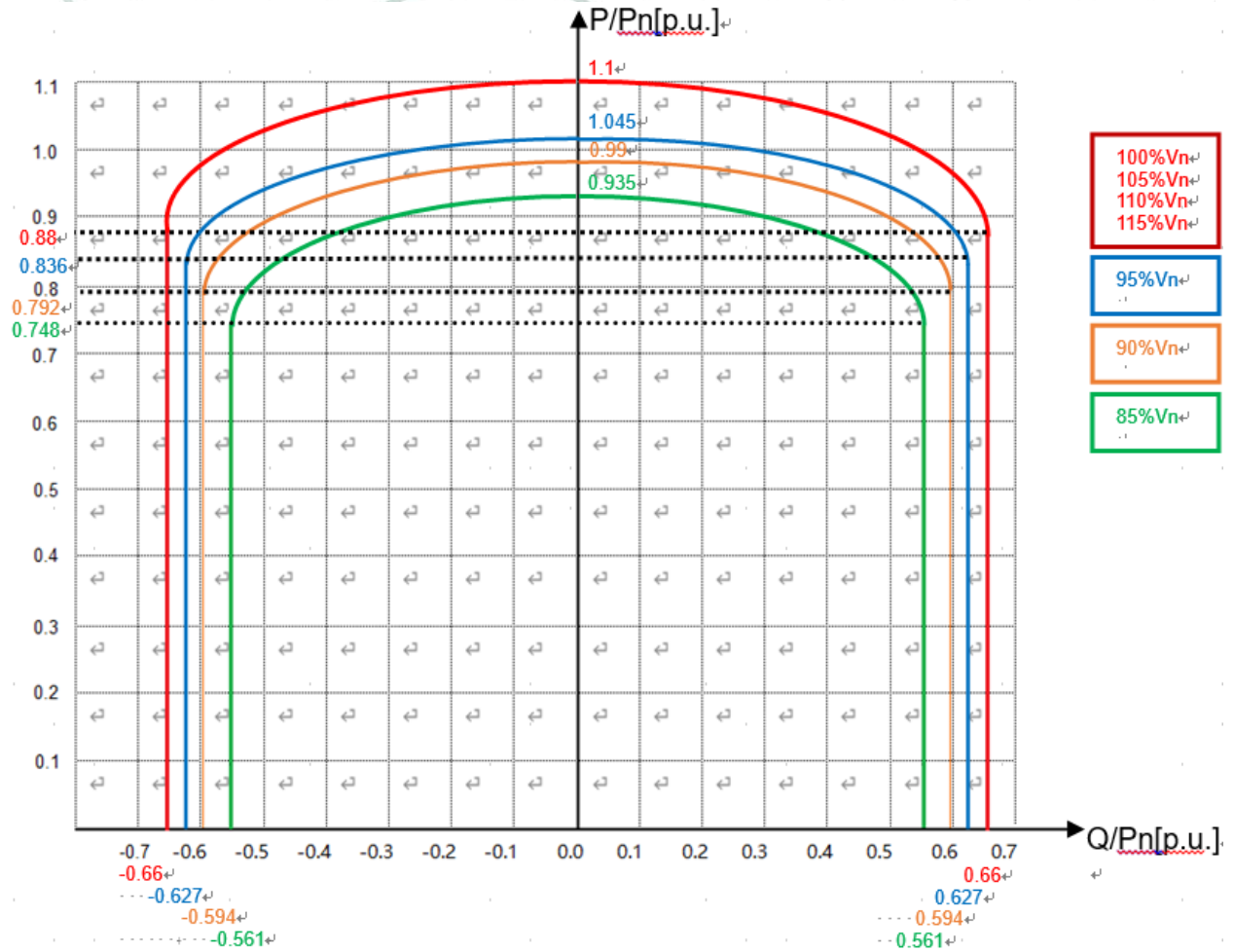

This P-Q diagram is declared by the manufacturer at environmental conditions corresponding up to 45°C at ambient temperature.

2.3.3 Blindleistungsbereitstellung / Provision of reactive power

Blindleistungsregelung im Normalbetrieb und maximaler Blindleistungstellbereich / Control of reactive power in normal operation and maximum reactive power range	P/Pn	Qind	Q0	Qkap	P/Pn	Qind	Q0	Qkap
	0%	0,557	0,536	0,557	60%	68.428	1.549	67.283
	10%	68,252	1,422	67,829	70%	68.509	1.604	67.169
	20%	68,251	1,527	67,698	80%	68.565	1.703	67.043
	30%	68,270	1,438	67,598	90%	68.617	1.805	66.935
	40%	68,311	1,400	67,440	100%	68.611	1.993	66.944
	50%	68,397	1,471	67,344	(*) See note below.			
Q in kVAr								
Arbeitspunkte des spannungsabhängigen P-Q Diagramms / Working points of the voltage dependent P-Q diagram	AP / WP		U/Un in %		P/Pn in %		Q in kVAr	
	1 ind		89,7		73,5		68,765	
	2 ind		109,7		90,0		68,444	
	1 kap / cap		89,9		75,6		66,935	
	2 kap / cap		109,8		90,1		66,894	
Blindleistungsregelung durch Sollwertvorgabe / Control of reactive power through set point signal	□Verschiebungsfaktor / power factor				☒Blindleistung / reactive power			
	Pbin bei / at Qmax				50 %Pn			
Längste Einschwingzeit / Longest response time	Parameter				Einschwingzeit / settling time			
	T < 6 s				0,4 s			
	Standardzeit / standard time				--			
	T < 60 s				62,2 s			
Einstellgenauigkeit des Verschiebungsfaktors bzw. Blindleistung / Positioning accuracy of power factor or reactive power	Sollwert / setpoint				Istwert / measured value			
	33,000 kVAr				32,402 kVAr			
	0 kVA				-0,187 kVAr			
	-33,000 kVA				-33,970 kVAr			
Anmerkung / remark	Soweit Q(U) und Q(P)- Regelung wurde, sind diese im Prüfbericht hinterlegt / See Q(U) and Q(P) in test report							

(*) The inverter can't reach the desired active power due to it is reactive power priority in this mode. Working at 90% Un the inverter does not reach the maximum 110% Sn due to the current limitation function. Maximum apparent power that can be reached corresponds to 100%Sn, approximately.

In following charts, they are offered main results after performed tests included in the FGW TG3 test report.

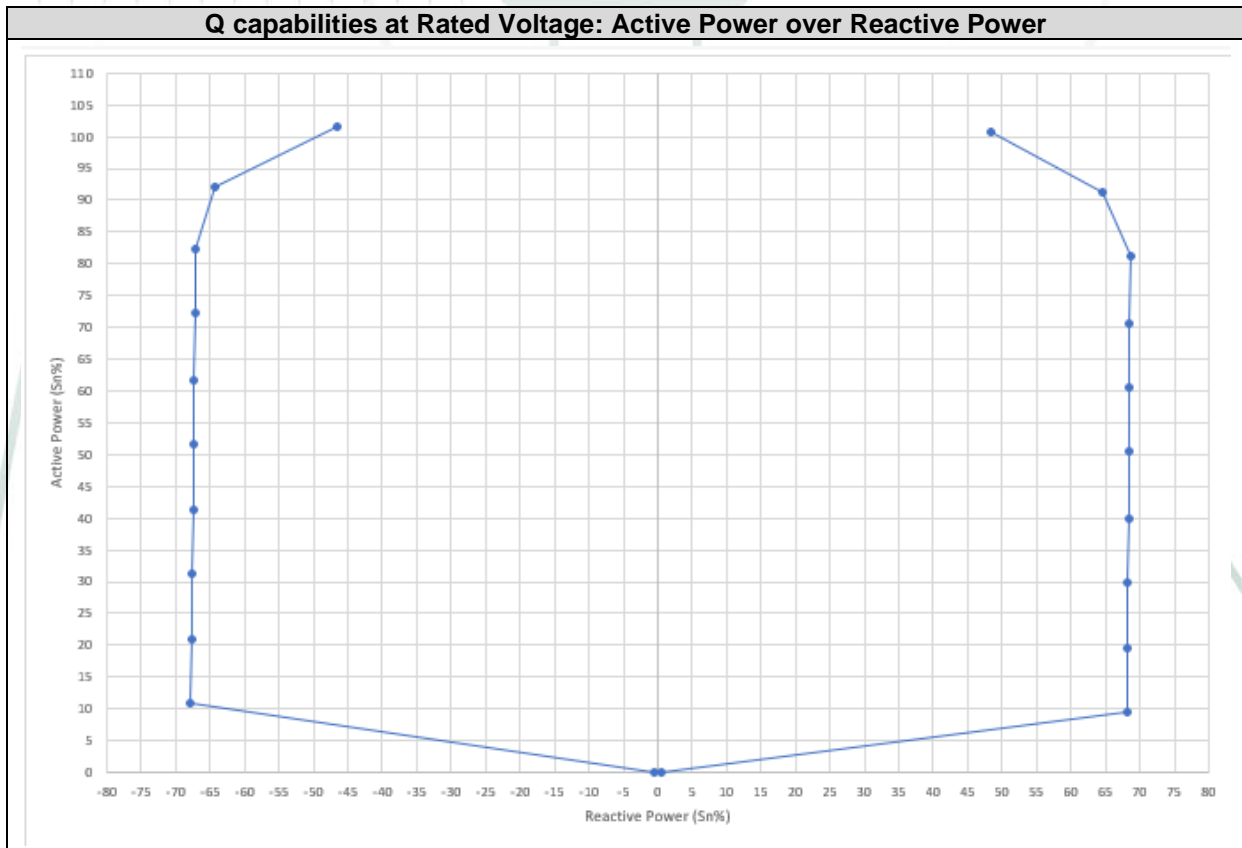
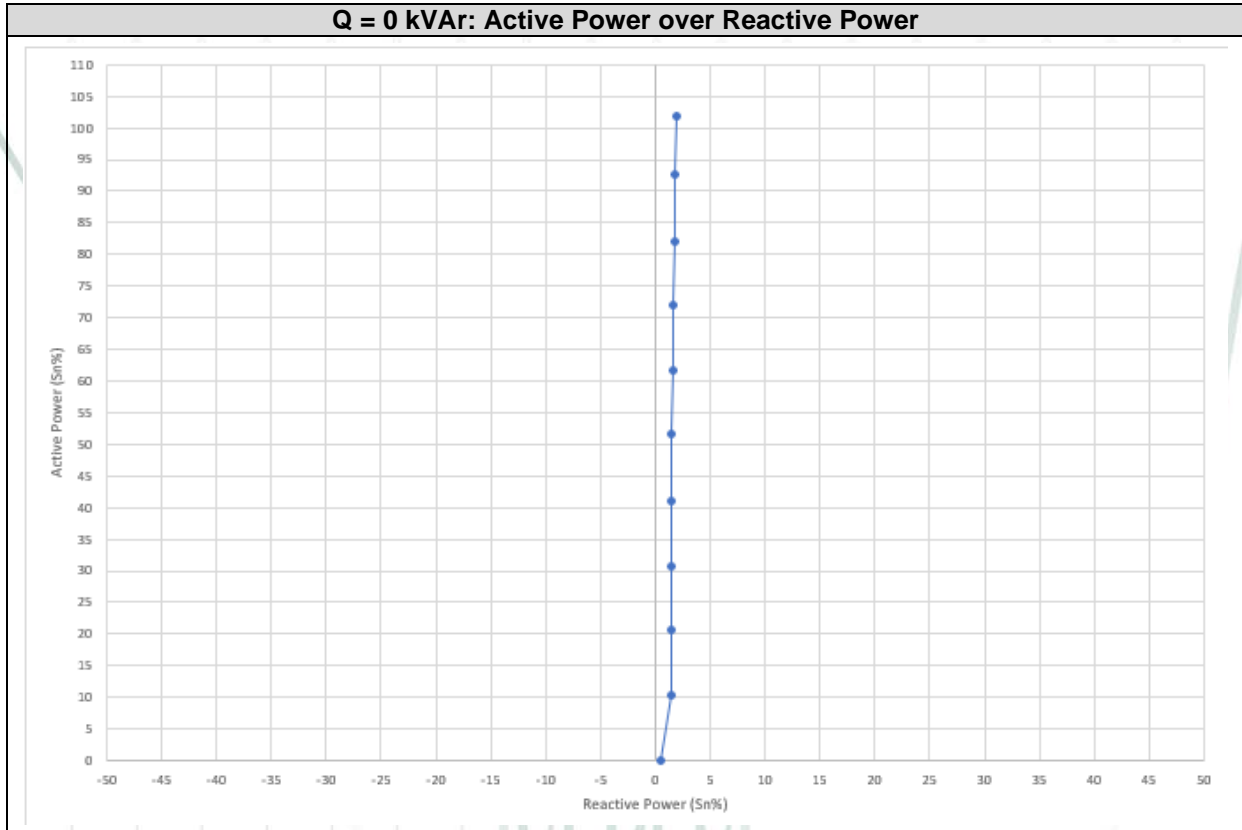

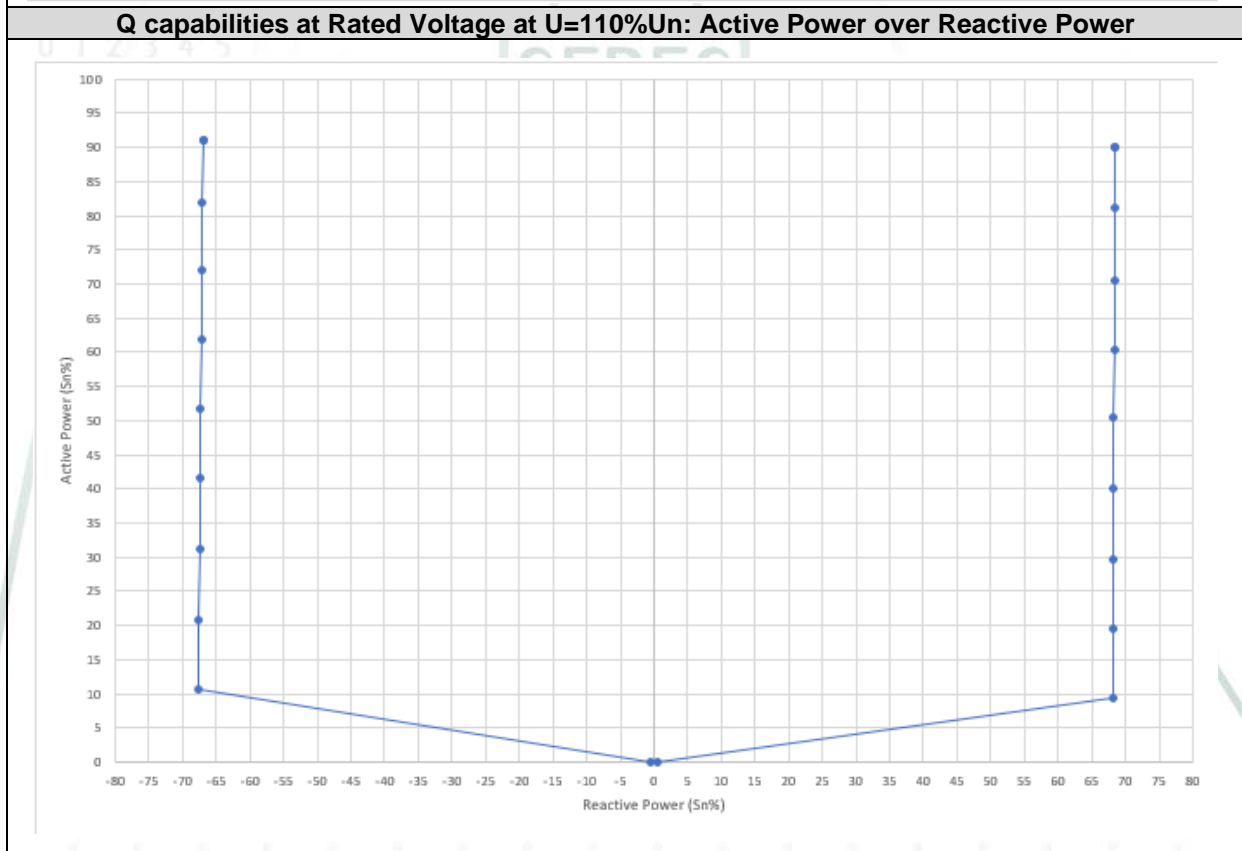
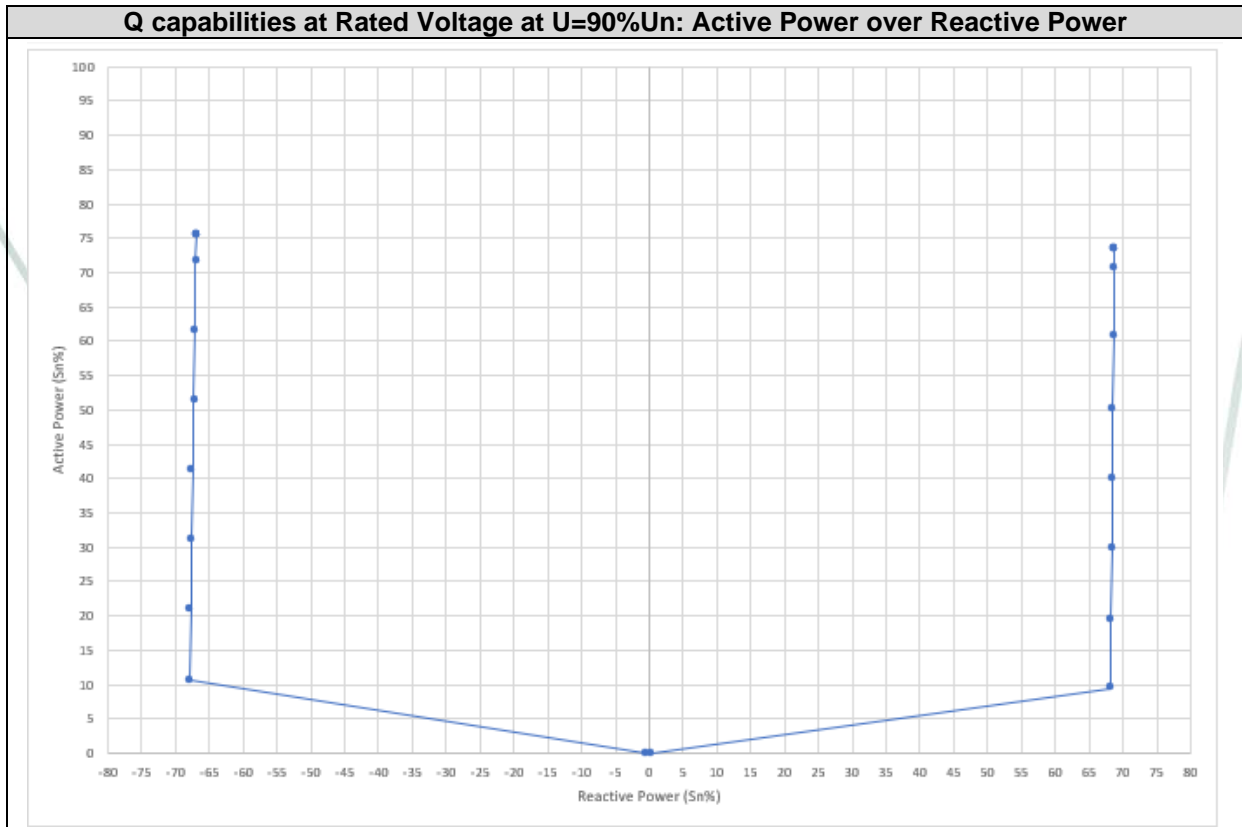

2.4 Protection system

2.4.1 Trennung der EZE vom Netz / Cut-off from grid

<input checked="" type="checkbox"/> Die Überprüfung der Gesamtwirkungskette führte zu einer erfolgreichen Abschaltung. The test of the whole trip circuit led to a successful shut down							
	Einstellwert Setting In pu oder/or [Hz]		Auslösewert / Release value In pu oder/or [Hz]		Abschaltzeit / Disconnection time [ms]		Rückfallverhältnis Disengaging ratio
	Schwelle / value	Zeit / time	Min.	Max.	Min.	Max.	
Spannungssteigerungsschutz/ Overvoltage protection: U>	1,000	180,00 s	1,005	1,005	179,00 s	179,00 s	□≥0.98 <input checked="" type="checkbox"/> <0.98
	1,300	0,100 s	1,296	1,299	0,101 s	0,138 s	
Spannungssteigerungsschutz/ Overvoltage protection: U>>	1,000	0,100 s	1,004	1,004	0,098 s	0,100 s	---
	1,300	0,050 s	1,303	1,309	0,060 s	0,071 s	
Spannungsrückgangsschutz/ Undervoltage protection: U<	0,100	0,050 s	0,099	0,104	0,052 s	0,057 s	□≤1.02 <input checked="" type="checkbox"/> >1.02
	1,000	2400,00 s	0,998	0,999	2353 s	2373 s	
Spannungsrückgangsschutz/ Undervoltage protection: U<<	0,100	0,050 s	0,099	0,100	0,051 s	0,056 s	□≤1.02 <input checked="" type="checkbox"/> >1.02
	1,000	0,800 s	1,000	1,002	0,760 s	0,798 s	
Frequenzsteigerungsschutz/ Overfrequency protection: F>	50,00	5,000 s	50,01		4,916 s		---
	55,00	0,100 s	54,99		0,115 s		
Frequenzsteigerungsschutz/ Overfrequency protection: F>>	50,00	0,100 s	50,01		0,100 s		---
	55,00	0,050 s	55,01		0,071 s		
Frequenzrückgangsschutz/ Underfrequency protection: F<	45,00	0,100 s	45,00		0,070 s		---
	50,00	0,100 s	50,01		0,080 s		
Eigenzeit der Abschaltzeit / Operating time of a circuit breaker:	<input checked="" type="checkbox"/> aus Messung by measurement				<input type="checkbox"/> aus Prüfzertifikat by test certificate		

In addition, Sungrow Power Supply Co. has submitted the manufacturer's certificate for the requirements of the protection function of generation units as defined below:

The following points are upheld:

- The setting values of the mains protection can be viewed directly on the display of the inverter.
- The protective device operates autonomously from the other control and control functions.
- The required auxiliary power supply can be maintained for at least 5 seconds.
- Any kind of fault in the controller (such as failure of the auxiliary power supply) causes the power generation to be switched off without delay and triggering of the PGU's main switch.
- No test terminal for protection test is provided without disconnect the wires. Such test terminal would be supplied at the system level on the LV side of the MV transformer.

There is only over-voltage self-protective parameter for the inverter: 1.40 Un for 1 ms.

2.4.2 Zuschaltbedingungen / Cut-in conditions

	Bereich / range In pu order/ or [Hz]	Zuschaltung erfolgte im angegebenen Bereich / cut in occurred within the given range
Zspannung / Voltage:	0,90 – 1,10	<input type="checkbox"/> nein / no <input checked="" type="checkbox"/> ja / yes
Frequenz / Frequency:	47,5 – 50,2	<input type="checkbox"/> nein / no <input checked="" type="checkbox"/> ja / yes

2.4.3 Zuschaltbedingungen nach Auslösung des Entkopplungsschutzes / Cut-in conditions after tripping of protection

	Bereich / range In pu order/ or [Hz]	Zuschaltung erfolgte im angegebenen Bereich cut in occurred within the given range
Unterspannung / Undervoltage:	> 0,95	<input type="checkbox"/> nein / no <input checked="" type="checkbox"/> ja / yes
Unterfrequenz / Underfrequency:	≥ 49,9	<input type="checkbox"/> nein / no <input checked="" type="checkbox"/> ja / yes
Überfrequenz / Overfrequency:	≤ 50,1	<input type="checkbox"/> nein / no <input checked="" type="checkbox"/> ja / yes

As evidenced in the FGW TG3 test report, the certified unit follows a ramp gradient inside of the range 33%Pn/s – 66%Pn/s after the reconnection occurs.

Graphical representation of the test over time

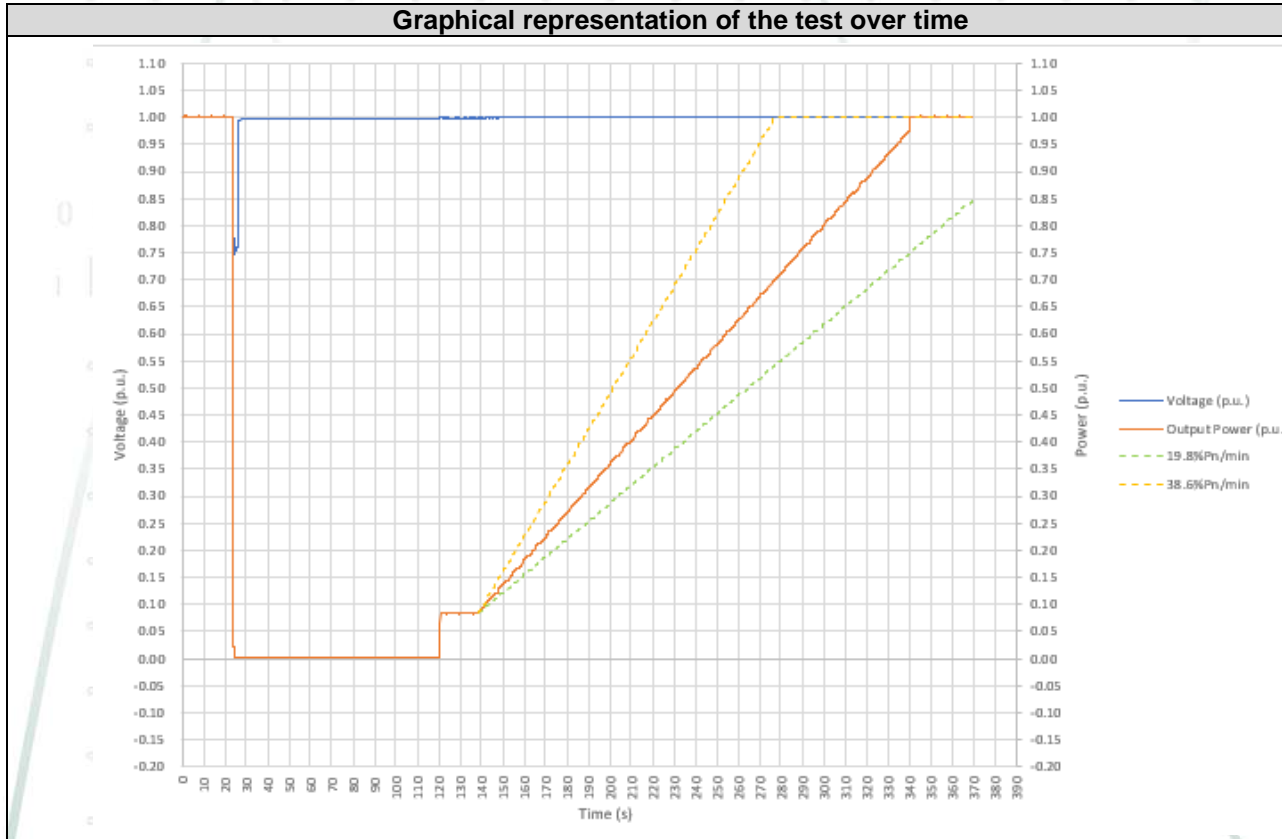

2.5 Response during grid faults

The compliance with these requirements including all calculations defined in the FGW TR3 standard is stated in the attachment to the test report:

- 2219 / 0375 ATTACHMENT I-E1 : FGW-TG3: Grid Fault Tests Results

Short circuit levels declared by the manufacturer are stated in the table below:

Inverter type	Peak short-circuit current I_p (A)	Initial symmetrical short-circuit current I_k'' (A)	Steady-state short-circuit current I_k (A)	Maximal current I_{max} (A)
SG110CX	300	175	158.8	158.8

The instantaneous values of AC currents and voltages are recorded synchronously with 50kHz (20 μ s). Positives sequence component are based on measurement of instantaneous voltages and currents are calculated according to IEC 61400-21 (2008).

R.m.s. value of the source current for three-phase fault I_{skPF} (First 1-2 cycles of the Fault) = 175 A.
R.m.s. value of the source current for two-phase fault $I(1)_{sk2PF}$ (First 1-2 cycles of the Fault) = 157,5 A.
R.m.s. value of the source current for single-phase fault $I(1)_{sk1PF}$ (First 1-2 cycles of the Fault) = 150 A.
Negative sequence short circuit impedance for all integer K factors is 1,618~9999 p.u. @stable status.

3 OVERVIEW OF RESULTS OF THE FGW TR4 VALIDATION REPORT

Report Number: 2219 / 0375 – TR4 with date 2019-01-30 according FGW TR4 rev. 9.

Software Characteristics

- Software type: Simulator for Grid Connected Power Conversion System
- Simulation platform: DigSilent PowerFactory
- Used version of the simulation platform: 15.2.9 (*)
- Simulation Software File identification: Project for SG110CX.pfd
- Dynamic Simulation Model version: V6
- MD5 Checksum: 326DBE8E8653557F34370591C169F8D5

(*) Simulation results offered in the validation report were obtained with the Powerfactory Digsilent Version 15.2.9. The validation report doesn't cover upper version of Digsilent above V15.2.9.

Revision 2

Report Number: 2219 / 0375 / A - TG4 demonstrates that the updated Dynamic Simulation Model (version 3.0) does not show any critical change compared to the previous version used in the original report number 2219 / 0375 - TG4. For more details see clause 3.1.3 of this Annex to Certificate

Software Characteristics used on Report 2219 / 0375/ A - TG4

- Software type: Simulator for Grid Connected Power Conversion System
- Simulation platform: Digsilent Power Factory 2021 SP4B
- Used version of the simulation platform: Version 21.0.6.0 (*)
- Simulation Software File identification: VDE_SG110CX_PF2019.pfd
- Dynamic Simulation Model version: V3.0
- MD5 Checksum: 3FCC9FA23AE8972266BE9028106FE02A

(*) Simulation results offered in the validation report were obtained with the Powerfactory Digsilent Version 21.0.6.0. The validation report doesn't cover upper version of Digsilent above Version 21.0.6.0.

Revision 3

Report Number: 2219 / 0375 / A – E1 - TG4 contains the updated MD5 Checksum reference due to a typo in previous MD5 Checksum reference.
The dynamic simulation model itself has not changed, therefore no further testing is required.

Software Characteristics used on Report 2219 / 0375/ A – E1 - TG4

- Software type: Simulator for Grid Connected Power Conversion System
- Simulation platform: Digsilent Power Factory 2021 SP4B
- Used version of the simulation platform: Version 21.0.6.0 (*)
- Simulation Software File identification: VDE_SG110CX_PF2019.pfd
- Dynamic Simulation Model version: V3.0
- MD5 Checksum: 03383A92CB1A1C003CA3A000C295CB6B

(*) Simulation results offered in the validation report were obtained with the Powerfactory Digsilent Version 21.0.6.0. The validation report doesn't cover upper version of Digsilent above Version 21.0.6.0.

The model is in accordance with the requirements of the clause 5 of FGW TR4 rev.9. The validation of the dynamic simulation model has been performed in order to be compliant with evaluations required in the point 2.3.3 of the standard FGW TR8, rev9.

Requirements of the clause 11.2.6.3 of standards VDE-AR-N 4110: 2018 and VDE-AR-N 4120: 2018 have been considered for the evaluation process.

Deviations evaluated for MXE, ME and MAE calculations are in accordance with the chapter 5.3 of FGW TR4 rev.9.

The validation plan is according with the chapter 5.1 of FGW TR4 rev.9. where following tests have been used for validation:

- Validation requirements for voltage ride through:
This involves the validation of symmetrical and asymmetrical test cases defined in the table 4-69 of the chapter 4.6.3 of FGW TR3 rev.25 for Type 2 PGUs.
- Validation requirements for reactive power control processes:
This involves the validation of accuracy requirements defined in chapters 4.2.5 (Q vs U) and 4.2.6 (Q vs P) of FGW TR3 rev.25.
- Verification of requirements for protective settings:
This involves the verification of the parameters for protection devices and settings declared by default for the certified product.

The validation overview for VRT cases is compliant with the Annex A.1.1, included in the report and compared with the validation overview in accordance with the table A-1. See FRT validation results in the point 2.1 of this document.

The additional plausibility tests have been performed in accordance with the chapter 5.5 of FGW TR4 rev.9.

See further information of the dynamic simulation model and the software used in the point 4 of this annex.

3.1 Validation results

3.1.1 Validation overview

The following table shows the FRT validation results in terms of deviations as defined by the standard for the positive and negative sequences of currents and powers in symmetrical and asymmetrical fault conditions at nominal and partial power.

All deviations are in accordance to the regular maximum tolerances given by the standard.

Test designation compliant with TR3, Chapter 4.6 Response during grid faults. Table 4-67			Three phase voltage drops in Positive phase sequence system											
			P			Q			Ia			Iq		
			MXE	ME	MAE	MXE	ME	MAE	MXE	ME	MAE	MXE	ME	MAE
Ures ≤ 0,05 0.1 3ph/100%/2	In accordance with IEC	Pre	0,0274	-0,0254	0,0254	0,0077	0,0072	0,0072	0,0638	0,0618	0,0618	0,0070	0,0066	0,0066
		Fault	-- (*)	-- (*)	-- (*)	-- (*)	-- (*)	-- (*)	-- (*)	-- (*)	-- (*)	-- (*)	-- (*)	-- (*)
		Post	0,0327	-0,0239	0,0271	0,0231	0,0081	0,0107	0,0667	0,0598	0,0610	0,0210	0,0058	0,0096
Ures ≤ 0,05 0.2 3ph/20%/2	In accordance with IEC	Pre	0,0082	-0,0046	0,0046	0,0000	0,0000	0,0000	0,0134	0,0125	0,0125	0,0007	0,0003	0,0003
		Fault	-- (*)	-- (*)	-- (*)	-- (*)	-- (*)	-- (*)	-- (*)	-- (*)	-- (*)	-- (*)	-- (*)	-- (*)
		Post	0,0128	-0,0043	0,0057	0,0000	0,0000	0,0000	0,0197	0,0126	0,0130	0,0053	-0,0011	0,0023
0,20 ≤ Ures ≤ 0,30 25.1 3ph/100%/2	In accordance with IEC	Pre	0,0271	-0,0255	0,0255	0,0079	0,0073	0,0073	0,0627	0,0614	0,0614	0,0072	0,0066	0,0066
		Fault	0,0185	-0,0224	0,0035	0,0198	0,0236	0,0188	0,0736	-0,0228	0,0120	0,1322	0,1497	0,1279
		Post	0,0304	-0,0157	0,0323	0,0238	0,0074	0,0104	0,0648	0,0686	0,0687	0,0217	0,0053	0,0096
0,20 ≤ Ures ≤ 0,30 25.2 3ph/20%/2	In accordance with IEC	Pre	0,0076	-0,0049	0,0049	0,0006	0,0003	0,0003	0,0127	0,0119	0,0119	0,0006	0,0003	0,0003
		Fault	0,0162	-0,0062	0,0035	0,0150	0,0185	0,0140	0,0632	-0,0080	0,0113	0,1315	0,1494	0,1277
		Post	0,0076	-0,0040	0,0059	0,0086	0,0002	0,0034	0,0146	0,0126	0,0128	0,0078	-0,0015	0,0031
0,45 ≤ Ures ≤ 0,60 50.1 3ph/100%/2	In accordance with IEC	Pre	0,0284	-0,0260	0,0260	0,0076	0,0070	0,0070	0,0687	0,0668	0,0668	0,0070	0,0064	0,0064
		Fault	0,0083	-0,0185	0,0078	0,0170	0,0215	0,0163	0,0117	-0,0199	0,0106	0,1279	0,1371	0,1265
		Post	0,0321	-0,0247	0,0276	0,0249	0,0060	0,0098	0,0696	0,0654	0,0656	0,0226	0,0043	0,0095
0,45 ≤ Ures ≤ 0,60 50.2 3ph/20%/2	In accordance with IEC	Pre	0,0056	-0,0045	0,0046	0,0011	0,0002	0,0002	0,0195	0,0128	0,0128	0,0010	0,0002	0,0002
		Fault	0,0095	-0,0101	0,0087	0,0080	0,0120	0,0071	0,0131	-0,0118	0,0115	0,1279	0,1363	0,1263
		Post	0,0082	-0,0041	0,0058	0,0061	-0,0011	0,0027	0,0159	0,0130	0,0132	0,0056	-0,0021	0,0031
0,45 ≤ Ures ≤ 0,60 50.5 3ph/20%/2L	In accordance with IEC	Pre	0,0288	-0,0259	0,0259	0,0081	0,0073	0,0073	0,0691	0,0667	0,0667	0,0074	0,0066	0,0066
		Fault	0,0186	-0,0320	0,0181	0,0073	0,0020	0,0071	0,0365	-0,0472	0,0354	0,0149	0,0048	0,0144
		Post	0,0327	-0,0230	0,0288	0,0239	0,0088	0,0093	0,0686	0,0667	0,0670	0,0217	0,0079	0,0084
0,70 ≤ Ures ≤ 0,80 75.1 3ph/100%/2	In accordance with IEC	Pre	0,0278	-0,0257	0,0257	0,0077	0,0070	0,0070	0,0633	0,0612	0,0612	0,0070	0,0063	0,0063
		Fault	0,0049	-0,0062	0,0028	0,0043	0,0016	0,0023	0,0107	-0,0004	0,0079	0,0491	0,0522	0,0473
		Post	0,0304	-0,0215	0,0280	0,0229	0,0057	0,0093	0,0652	0,0629	0,0629	0,0208	0,0048	0,0088
0,70 ≤ Ures ≤ 0,80 75.2 3ph/20%/2	In accordance with IEC	Pre	0,0052	-0,0044	0,0044	0,0005	0,0002	0,0002	0,0138	0,0128	0,0128	0,0005	0,0002	0,0002
		Fault	0,0017	-0,0001	0,0012	0,0101	0,0114	0,0079	0,0074	0,0057	0,0067	0,0752	0,0767	0,0722
		Post	0,0072	-0,0035	0,0057	0,0109	-0,0009	0,0027	0,0144	0,0137	0,0138	0,0099	-0,0012	0,0028
0,70 ≤ Ures ≤ 0,80 75.3 3ph/20%/2	In accordance with IEC	Pre	0,0078	-0,0050	0,0050	0,0018	0,0012	0,0012	0,0123	0,0118	0,0118	0,0075	-0,0071	0,0071
		Fault	0,0099	0,0066	0,0084	0,0166	0,0195	0,0154	0,0179	0,0145	0,0159	0,0735	0,0764	0,0718
		Post	0,0290	-0,0026	0,0054	0,0161	-0,0026	0,0061	0,0155	0,0139	0,0139	0,0182	-0,0112	0,0117
0,70 ≤ Ures ≤ 0,80 75.4 3ph/20%/2	In accordance with IEC	Pre	0,0111	-0,0080	0,0080	0,0049	0,0043	0,0043	0,0100	0,0095	0,0095	0,0129	0,0123	0,0123
		Fault	0,0087	0,0064	0,0082	0,0203	0,0227	0,0192	0,0164	0,0143	0,0158	0,1001	0,1032	0,0987
		Post	0,0512	-0,0056	0,0083	0,0194	0,0007	0,0083	0,0296	0,0116	0,0118	0,0243	0,0081	0,0147
0,70 ≤ Ures ≤ 0,80 75.5 3ph ≥ 10%/4	In accordance with IEC	Pre	0,0055	-0,0044	0,0044	0,0029	-0,0025	0,0025	0,0137	0,0128	0,0128	0,0027	-0,0023	0,0023
		Fault	0,0193	0,0162	0,0174	0,0304	0,0357	0,0296	0,0287	0,0254	0,0263	0,1286	0,1355	0,1276
		Post	0,0116	-0,0035	0,0053	0,0086	-0,0044	0,0057	0,0200	0,0136	0,0138	0,0078	-0,0048	0,0058

(*) According to the clause 5.3.1 of FGW TR4 (rev 9), the fault range doesn't require of evaluation for voltage dips below 5%Un.

Test designation compliant with TR3, Chapter 4.6 Response during grid faults. Table 4-67			Three phase voltage drops in Positive phase sequence system											
			P			Q			Ia			Iq		
			MXE	ME	MAE	MXE	ME	MAE	MXE	ME	MAE	MXE	ME	MAE
0,75≤Ures≤0,85 80.1 3ph/100%/2L	In accordance with IEC	Pre	0,0043	-0,0035	0,0035	0,0021	0,0016	0,0016	0,0847	0,0833	0,0833	0,0019	0,0015	0,0015
		Fault	0,0151	-0,0221	0,0145	0,0086	-0,0037	0,0067	0,0162	-0,0226	0,0155	0,0397	0,0405	0,0368
		Post	0,0101	-0,0014	0,0100	0,0095	-0,0028	0,0057	0,0871	0,0830	0,0830	0,0087	-0,0032	0,0058
0,85≤Ures≤0,90 85.1 3ph/100%/2	In accordance with IEC	Pre	0,0246	-0,0220	0,0220	0,0130	-0,0123	0,0123	0,0721	0,0701	0,0701	0,0119	-0,0112	0,0112
		Fault	0,0088	-0,0067	0,0063	0,0036	0,0000	0,0008	0,0073	-0,0053	0,0015	0,0297	0,0258	0,0257
		Post	0,0263	-0,0185	0,0253	0,0136	-0,0122	0,0129	0,0000	0,0712	0,0000	0,0124	-0,0113	0,0119
Ures≥1,15 115.1 3ph/100%/2	In accordance with IEC	Pre	0,0246	-0,0218	0,0218	0,0131	-0,0123	0,0123	0,0712	0,0683	0,0683	0,0119	-0,0112	0,0112
		Fault	0,0065	-0,0013	0,0054	0,0271	-0,0247	0,0228	0,0069	0,0002	0,0061	0,0512	-0,0492	0,0478
		Post	0,0307	-0,0199	0,0258	0,0130	-0,0096	0,0124	0,0700	0,0675	0,0675	0,0119	-0,0088	0,0112
Ures≥1,15 115.2 3ph/20%/2	In accordance with IEC	Pre	0,0050	-0,0040	0,0041	0,0030	-0,0024	0,0024	0,0210	0,0141	0,0141	0,0028	-0,0022	0,0022
		Fault	0,0050	0,0027	0,0041	0,0246	-0,0248	0,0228	0,0058	0,0038	0,0050	0,0492	-0,0493	0,0477
		Post	0,0078	-0,0027	0,0051	0,0067	-0,0001	0,0042	0,0174	0,0153	0,0153	0,0061	-0,0002	0,0037
Ures≥1,10 110.3 3ph≥10%/2	In accordance with IEC	Pre	0,0054	-0,0045	0,0045	0,0028	-0,0024	0,0024	0,0155	0,0137	0,0137	0,0026	-0,0022	0,0022
		Fault	0,0033	0,0006	0,0008	0,0042	-0,0004	0,0007	0,0043	0,0023	0,0007	0,0240	-0,0209	0,0208
		Post	0,0079	-0,0032	0,0056	0,0100	0,0001	0,0044	0,0000	0,0149	0,0000	0,0091	0,0000	0,0039

0 1 2 3 4 5



Test designation compliant with TR3, Chapter 4.6 Response during grid faults. Table 4-67			Two phase voltage drops in Positive phase sequence system											
			P			Q			Ia			Iq		
			MXE	ME	MAE	MXE	ME	MAE	MXE	ME	MAE	MXE	ME	MAE
Ures ≤ 0,05 0.3 2ph/100%/2	In accordance with IEC	Pre	0,0253	-0,0223	0,0223	0,0130	-0,0121	0,0121	0,0772	0,0749	0,0749	0,0118	-0,0110	0,0110
		Fault	0,0071	-0,0531	0,0064	0,0099	0,0219	0,0090	0,0091	-0,0464	0,0075	0,0846	0,1180	0,0824
		Post	0,0287	-0,0202	0,0237	0,0131	-0,0116	0,0132	0,0770	0,0737	0,0739	0,0119	-0,0116	0,0119
Ures ≤ 0,05 0.4 2ph/20%/2	In accordance with IEC	Pre	0,0047	-0,0037	0,0037	0,0027	-0,0024	0,0024	0,0141	0,0133	0,0133	0,0025	-0,0022	0,0022
		Fault	0,0080	-0,0136	0,0073	0,0077	0,0191	0,0069	0,0100	-0,0071	0,0083	0,0888	0,1204	0,0869
		Post	0,0065	-0,0029	0,0047	0,0029	-0,0026	0,0043	0,0162	0,0138	0,0139	0,0027	-0,0034	0,0037
0,20 ≤ Ures ≤ 0,30 25.4 2ph/100%/2	In accordance with IEC	Pre	0,0255	-0,0225	0,0225	0,0134	-0,0122	0,0122	0,0756	0,0733	0,0733	0,0122	-0,0111	0,0111
		Fault	0,0073	-0,0226	0,0064	0,0147	0,0185	0,0133	0,0072	-0,0194	0,0054	0,0786	0,0873	0,0760
		Post	0,0274	-0,0208	0,0225	0,0135	-0,0119	0,0131	0,0766	0,0720	0,0724	0,0123	-0,0116	0,0119
0,20 ≤ Ures ≤ 0,30 25.5 2ph/20%/2	In accordance with IEC	Pre	0,0050	-0,0039	0,0039	0,0028	-0,0024	0,0024	0,0161	0,0132	0,0132	0,0025	-0,0022	0,0022
		Fault	0,0080	-0,0094	0,0073	0,0121	0,0162	0,0114	0,0071	-0,0059	0,0057	0,0835	0,0925	0,0822
		Post	0,0070	-0,0034	0,0049	0,0065	-0,0023	0,0042	0,0163	0,0135	0,0137	0,0060	-0,0029	0,0039
0,45 ≤ Ures ≤ 0,60 50.3 2ph/100%/2	In accordance with IEC	Pre	0,0249	-0,0224	0,0224	0,0131	-0,0122	0,0122	0,0761	0,0702	0,0702	0,0119	-0,0111	0,0111
		Fault	0,0075	-0,0160	0,0062	0,0129	0,0146	0,0107	0,0027	-0,0096	0,0008	0,0690	0,0715	0,0657
		Post	0,0270	-0,0225	0,0232	0,0130	-0,0122	0,0128	0,0729	0,0674	0,0677	0,0118	-0,0117	0,0119
0,45 ≤ Ures ≤ 0,60 50.4 2ph/20%/2	In accordance with IEC	Pre	0,0049	-0,0041	0,0041	0,0028	-0,0024	0,0024	0,0154	0,0131	0,0131	0,0025	-0,0022	0,0022
		Fault	0,0079	-0,0085	0,0074	0,0132	0,0147	0,0111	0,0017	-0,0014	0,0010	0,0794	0,0820	0,0765
		Post	0,0081	-0,0035	0,0048	0,0033	-0,0030	0,0038	0,0164	0,0134	0,0136	0,0030	-0,0033	0,0037
0,45 ≤ Ures ≤ 0,60 50.6 2ph/100%/2L	In accordance with IEC	Pre	0,0022	0,0009	0,0010	0,0073	0,0068	0,0068	0,0875	0,0870	0,0870	0,0067	0,0062	0,0062
		Fault	0,0076	-0,0058	0,0066	0,0008	-0,0017	0,0001	0,0149	0,0023	0,0134	0,0012	-0,0023	0,0001
		Post	0,0081	0,0043	0,0063	0,0078	0,0054	0,0082	0,0935	0,0875	0,0876	0,0071	0,0049	0,0074
0,75 ≤ Ures ≤ 0,85 75.6 3ph/100%/2	In accordance with IEC	Pre	0,0255	-0,0229	0,0229	0,0129	-0,0122	0,0122	0,0781	0,0754	0,0754	0,0117	-0,0111	0,0111
		Fault	0,0025	-0,0087	0,0005	0,0081	0,0085	0,0059	0,0097	0,0008	0,0083	0,0462	0,0464	0,0435
		Post	0,0284	-0,0215	0,0247	0,0134	-0,0124	0,0126	0,0799	0,0741	0,0743	0,0122	-0,0115	0,0117
0,75 ≤ Ures ≤ 0,85 75.7 2ph/20%/2	In accordance with IEC	Pre	0,0078	-0,0040	0,0040	0,0028	-0,0024	0,0024	0,0140	0,0131	0,0131	0,0026	-0,0021	0,0021
		Fault	0,0019	-0,0013	0,0005	0,0068	0,0067	0,0044	0,0109	0,0075	0,0082	0,0432	0,0431	0,0404
		Post	0,0072	-0,0034	0,0046	0,0089	-0,0028	0,0041	0,0164	0,0136	0,0137	0,0081	-0,0028	0,0040
0,75 ≤ Ures ≤ 0,85 75.8 2ph ≥ 10%/4	In accordance with IEC	Pre	0,0882	-0,0044	0,0044	0,0543	-0,0023	0,0024	0,0224	0,0128	0,0128	0,0753	-0,0021	0,0023
		Fault	0,0033	-0,0020	0,0011	0,0240	0,0260	0,0220	0,0087	0,0070	0,0077	0,0793	0,0814	0,0768
		Post	0,0076	-0,0035	0,0047	0,0089	-0,0030	0,0045	0,0164	0,0135	0,0136	0,0081	-0,0031	0,0043
0,85 ≤ Ures ≤ 0,90 80.2 2ph/100%/0L	In accordance with IEC	Pre	0,0254	-0,0224	0,0224	0,0133	-0,0122	0,0122	0,0722	0,0697	0,0697	0,0121	-0,0111	0,0111
		Fault	0,0124	-0,0206	0,0115	0,0122	0,0103	0,0116	0,0118	-0,0194	0,0108	0,0135	0,0114	0,0128
		Post	0,0286	-0,0175	0,0236	0,0132	-0,0111	0,0113	0,0740	0,0720	0,0720	0,0120	-0,0101	0,0103
Ures ≥ 1,10 110.1 2ph/100%/2	In accordance with IEC	Pre	0,0075	-0,0037	0,0037	0,0070	0,0050	0,0050	0,0880	0,0843	0,0843	0,0064	0,0046	0,0046
		Fault	0,0056	-0,0061	0,0020	0,0182	-0,0162	0,0146	0,0115	0,0015	0,0084	0,0357	-0,0340	0,0328
		Post	0,0126	-0,0061	0,0110	0,0119	0,0069	0,0071	0,0911	0,0796	0,0825	0,0109	0,0061	0,0064
Ures ≥ 1,10 110.2 2ph/20%/2	In accordance with IEC	Pre	0,0067	-0,0060	0,0060	0,0015	0,0012	0,0012	0,0123	0,0116	0,0116	0,0014	0,0011	0,0011
		Fault	0,0055	0,0020	0,0033	0,0059	-0,0048	0,0029	0,0117	0,0088	0,0099	0,0257	-0,0249	0,0234
		Post	0,0094	-0,0053	0,0072	0,0033	0,0033	0,0033	0,0145	0,0122	0,0128	0,0030	0,0028	0,0029

Test designation compliant with TR3, Chapter 4.6 Response during grid faults. Table 4-67			Two phase voltage drops in Negative phase sequence system												
			P			Q			Ia			Iq			
			MXE	ME	MAE	MXE	ME	MAE	MXE	ME	MAE	MXE	ME	MAE	
Ures ≤ 0,05 0.3 2ph/100%/2	In accordance with IEC	Pre	0,0000	0,0000	0,0000	0,0000	0,0000	0,0000	0,0000	0,0094	-0,0058	0,0063	0,0161	-0,0133	0,0133
		Fault	0,0105	-0,0087	0,0089	0,0348	0,0247	0,0332	0,0304	-0,0250	0,0258	0,0724	0,0445	0,0675	
		Post	0,0000	0,0000	0,0001	0,0000	0,0004	0,0004	0,0137	-0,0057	0,0081	0,0161	-0,0098	0,0141	
Ures ≤ 0,05 0.4 2ph/20%/2	In accordance with IEC	Pre	0,0000	0,0000	0,0000	0,0000	0,0000	0,0000	0,0046	-0,0026	0,0030	0,0045	-0,0020	0,0020	
		Fault	0,0116	-0,0086	0,0090	0,0389	0,0282	0,0371	0,0336	-0,0249	0,0262	0,0777	0,0491	0,0724	
		Post	0,0000	0,0000	0,0001	0,0000	0,0004	0,0004	0,0045	-0,0018	0,0027	0,0046	-0,0010	0,0052	
0,20≤Ures≤0,30 25.4 2ph/100%/2	In accordance with IEC	Pre	0,0000	0,0000	0,0000	0,0000	0,0000	0,0000	0,0148	-0,0055	0,0077	0,0161	-0,0112	0,0112	
		Fault	0,0100	-0,0091	0,0092	0,0346	0,0295	0,0329	0,0272	-0,0246	0,0250	0,0725	0,0593	0,0679	
		Post	0,0000	0,0000	0,0001	0,0000	0,0004	0,0005	0,0173	-0,0059	0,0084	0,0163	-0,0085	0,0131	
0,20≤Ures≤0,30 25.5 2ph/20%/2	In accordance with IEC	Pre	0,0000	0,0000	0,0000	0,0000	0,0000	0,0000	0,0043	-0,0023	0,0023	0,0048	-0,0019	0,0030	
		Fault	0,0103	-0,0095	0,0097	0,0389	0,0348	0,0383	0,0282	-0,0258	0,0266	0,0770	0,0666	0,0755	
		Post	0,0000	0,0000	0,0001	0,0000	0,0005	0,0005	0,0046	-0,0019	0,0026	0,0047	-0,0010	0,0056	
0,45≤Ures≤0,60 50.3 2ph/100%/2	In accordance with IEC	Pre	0,0000	0,0000	0,0000	0,0000	0,0000	0,0000	0,0126	-0,0087	0,0087	0,0139	-0,0119	0,0119	
		Fault	0,0044	-0,0036	0,0036	0,0102	0,0076	0,0090	0,0151	-0,0124	0,0125	0,0049	-0,0033	0,0012	
		Post	0,0000	0,0000	0,0000	0,0000	0,0003	0,0004	0,0145	-0,0052	0,0059	0,0153	-0,0111	0,0150	
0,45≤Ures≤0,60 50.4 2ph/20%/2	In accordance with IEC	Pre	0,0000	0,0000	0,0000	0,0000	0,0000	0,0000	0,0043	0,0001	0,0015	0,0044	0,0004	0,0037	
		Fault	0,0046	-0,0037	0,0037	0,0152	0,0128	0,0143	0,0160	-0,0128	0,0131	0,0155	0,0077	0,0122	
		Post	0,0000	0,0000	0,0000	0,0000	0,0004	0,0004	0,0045	-0,0012	0,0034	0,0045	-0,0001	0,0045	
0,45≤Ures≤0,60 50.6 2ph/100%/2L	In accordance with IEC	Pre	0,0000	0,0000	0,0000	0,0000	0,0000	0,0000	0,0023	-0,0010	0,0010	0,0080	0,0074	0,0074	
		Fault	0,0011	0,0009	0,0009	0,0012	-0,0005	0,0011	0,0036	0,0027	0,0029	0,0038	-0,0012	0,0034	
		Post	0,0000	0,0000	0,0000	0,0000	0,0000	0,0000	0,0078	-0,0021	0,0033	0,0080	0,0068	0,0068	
0,75≤Ures≤0,85 75.6 3ph/100%/2	In accordance with IEC	Pre	0,0000	0,0000	0,0000	0,0000	0,0000	0,0000	0,0129	-0,0088	0,0088	0,0153	-0,0112	0,0112	
		Fault	0,0009	-0,0004	0,0004	0,0038	0,0029	0,0033	0,0059	-0,0028	0,0028	0,0197	-0,0196	0,0174	
		Post	0,0000	0,0000	0,0000	0,0000	0,0001	0,0002	0,0157	-0,0068	0,0081	0,0156	-0,0098	0,0122	
0,75≤Ures≤0,85 75.7 2ph/20%/2	In accordance with IEC	Pre	0,0000	0,0000	0,0000	0,0000	0,0000	0,0000	0,0044	-0,0021	0,0021	0,0046	-0,0030	0,0030	
		Fault	0,0009	-0,0005	0,0005	0,0012	0,0003	0,0008	0,0054	-0,0034	0,0034	0,0281	-0,0271	0,0249	
		Post	0,0000	0,0000	0,0000	0,0000	0,0002	0,0002	0,0044	-0,0019	0,0026	0,0046	-0,0021	0,0045	
0,75≤Ures≤0,85 75.8 2ph/≥10%/4	In accordance with IEC	Pre	0,0010	0,0000	0,0000	0,0126	0,0000	0,0000	0,0087	-0,0027	0,0027	0,0649	-0,0025	0,0025	
		Fault	0,0014	-0,0010	0,0010	0,0142	0,0127	0,0136	0,0093	-0,0067	0,0066	0,0380	0,0306	0,0353	
		Post	0,0000	0,0000	0,0000	0,0000	0,0003	0,0003	0,0045	-0,0025	0,0034	0,0047	-0,0002	0,0047	
0,85≤Ures≤0,90 80.2 2ph/100%/0L	In accordance with IEC	Pre	0,0000	0,0000	0,0000	0,0000	0,0000	0,0000	0,0135	-0,0103	0,0103	0,0135	-0,0106	0,0106	
		Fault	0,0008	0,0007	0,0007	0,0005	-0,0004	0,0004	0,0052	0,0041	0,0042	0,0034	-0,0022	0,0022	
		Post	0,0000	0,0000	0,0000	0,0000	0,0000	0,0000	0,0150	-0,0079	0,0080	0,0161	-0,0115	0,0116	
Ures≥1,10 110.1 2ph/100%/2	In accordance with IEC	Pre	0,0000	0,0000	0,0000	0,0000	0,0000	0,0000	0,0076	0,0038	0,0041	0,0074	0,0019	0,0032	
		Fault	0,0005	0,0001	0,0002	0,0020	-0,0019	0,0017	0,0036	0,0009	0,0010	0,0374	-0,0362	0,0348	
		Post	0,0000	0,0000	0,0000	0,0000	0,0001	0,0001	0,0076	0,0051	0,0055	0,0059	0,0003	0,0035	
Ures≥1,10 110.2 2ph/20%/2	In accordance with IEC	Pre	0,0000	0,0000	0,0000	0,0000	0,0000	0,0000	0,0022	0,0014	0,0014	0,0022	0,0001	0,0014	
		Fault	0,0004	0,0002	0,0002	0,0019	-0,0017	0,0015	0,0031	0,0016	0,0017	0,0353	-0,0342	0,0329	
		Post	0,0000	0,0000	0,0000	0,0000	0,0001	0,0001	0,0024	0,0015	0,0018	0,0024	0,0006	0,0025	

3.1.2 Additional tests

The following tests were performed to demonstrate that the updated Dynamic Simulation Model (version 3.0) does not show any critical change compared to the previous version used in the original report number 2219 / 0375 - TG4

- Simulation cases 0.1, 0.2, 0.3, 0.4, 50.6, 75.3, 75.4, 75.5, 75.8 and 80.2

The results are shown in the report no. 2219 / 0375 / A – E1 - TG4.

In addition, the manufacturer provides a statement that the updated Dynamic Simulation Model (version 3.0) does not result in any critical change to the previous version model.

Compromise letter

We **SUNGROW POWER SUPPLY CO., LTD.**

Declare that
The only change shown in the model (SG110CX) is:

The negative sequence angle input is added to the model, so the power flow model setting needs to start the negative sequence angle. to start the negative sequence angle, as shown in the figure below.

and the rest of the functions between version (V2.0) and version (V3.0) remain the same.

Date: Jan.19th, 2022

Name: Huang Jie
Charge: Standard and Certification Engineer
Signature: *Huang Jie*
Company Seal:

3.2 Validation conclusion

Once evaluated the entire tests required to carry out the comparison between simulation and real tests, it is demonstrated that the behaviours of the electronic equipment and its dynamic simulation model **FULLY COMPLIES (*)** with validation requirements according to the specifications of the standard:

- FGW Technical Guidelines for Power Generating Units. Part 4 - Revision 9, dated on 01/02/2019 (FGW TG4 Rev.9): Demands on Modelling and Validating Simulation Models of the Electrical Characteristics of Power Generating Units and Systems, Storage Systems as well as their Components.

Using as reference following standards:

- VDE-AR-N 4110: 2018-11. Technical requirements for the connection and operation of customer installations to the medium voltage network (TAR medium voltage).
- VDE-AR-N 4120: 2018-11. Technical requirements for the connection and operation of customer installations to the high voltage network (TAR high voltage).

(*) Simulation results offered in the validation report were obtained with the Powerfactory Digsilent Version 15.2.9. The validation report doesn't cover upper version of Digsilent above V15.2.9.

4 TECHNICAL DATA

4.1 Technical data

Type designation	SG110CX
Input (DC)	
Max. PV input voltage	1100 V
Min. PV input voltage / Startup input voltage	200 V / 250 V
Nominal PV input voltage	585 V
MPP voltage range	200 – 1000 V
MPP voltage range for nominal power	550V – 850 V
No. of independent MPP inputs	9
Max. number of PV strings per MPPT	2
Max. PV input current	26 A * 9
Max. DC short-circuit current	40 A * 9
Output (AC)	
AC output power	110 kVA @ 45 °C / 100 kVA @ 50 °C
Max. AC output current	158.8 A
Nominal AC voltage	3 / N / PE, 400 V
AC voltage range	320 – 460 V
Nominal grid frequency / Grid frequency range	50 Hz / 45 – 55 Hz, 60 Hz / 55 – 65 Hz
THD	< 3 % (at nominal power)
DC current injection	< 0.5 % In
Power factor at nominal power / Adjustable power factor	> 0.99 / 0.8 leading – 0.8 lagging
Feed-in phases / connection phases	3 / 3
Efficiency	
Max. efficiency	98.7 %
Euro. efficiency	98.5 %
Protection	
DC reverse connection protection	Yes
AC short circuit protection	Yes
Leakage current protection	Yes
Grid monitoring	Yes
Ground fault monitoring	Yes
DC switch	Yes (not available for Australia)
AC switch	No
PV String current monitoring	Yes
PID recovery function	Yes
Overvoltage protection	DC Type II / AC Type II
General Data	
Dimensions (W*H*D)	1051*660*362.5 mm
Weight	89 kg
Isolation method	Transformerless
Ingress protection rating	IP66
Night power consumption	< 2W
Operating ambient temperature range	-30 to 60 °C (> 50 °C derating)
Allowable relative humidity range (non-condensing)	0 – 100 %
Cooling method	Smart forced air cooling
Max. operating altitude	4000 m (> 3000 m derating)
Display	LED, Bluetooth+APP
Communication	RS485 / Optional: Wi-Fi, Ethernet
DC connection type	MC4 (Max. 6 mm ²)
AC connection type	OT / DT terminal (Max. 240 mm ²)
Compliance	IEC 62109, IEC 61727, IEC 62116, IEC 60068, IEC 61683, VDE-AR-N 4110:2018, VDE-AR-N 4120:2018, IEC 61000-6-3, EN 50549, AS/NZS 4777.2:2015, CEI 0-21, VDE 0126-1-1/A1 VFR 2014, UTE C15-712-1:2013, DEWA
Grid Support	Q at night function, LVRT, HVRT, active & reactive power control and power ramp rate control

4.2 Overview of important parameters of the generation unit

The following are important parameters of the generation unit. The specified "Default Values" do not automatically meet the requirements set out in VDE-AR-N 4110: 2018 and VDE-AR-N 4120: 2018.

The settings may be specific for each project and needed to be checked.

Parameter description	Unit	Default Value	Min.	Max.	Step- wide	Note
Behaviour in the event of disturbances in the network						
LVRT Protection Level		Fourth level				First Level / Second Level / Third Level / Fourth Level / Fifth Level
LVRT Voltage 1	V	207,0	0,0	230,0	0,1 V	
LVRT Time 1	ms	3600000	40	14400000	1 ms	
LVRT Voltage 2	V.	195,5	0,0	230,0	0,1 V	
LVRT Time 2	ms	3600000	40	14400000	1 ms	
LVRT Voltage 3	V	161,0	0,0	230,0	0,1 V	
LVRT Time 3	ms	5000	40	14400000	1 ms	
LVRT Voltage 4	V	34,5	0,0	230,0	0,1 V	
LVRT Time 4	ms	150	40	14400000	1 ms	
LVRT Exit		ON				ON / OFF
LVRT Exit Time	s	5	0	100	1s	
HVRT Protection Level		Third Level				First Level / Second Level / Third Level / Fourth Level / Fifth Level
HVRT Voltage 1	V	253,0	230,0	322,0	0,1 V	
HVRT Time 1	ms	1800000	40	14400000	1 ms	
HVRT Voltage 2	V.	276,0	230,0	322,0	0,1 V	
HVRT Time 2	ms	1800000	40	14400000	1 ms	
HVRT Voltage 3	V	287,5	230,0	322,0	0,1 V	
HVRT Time 3	ms	100	40	14400000	1 ms	
Zero Power mode		OFF				ON / OFF
HVRT Exit		ON				ON / OFF
HVRT Exit Time	s	5	0	100	1s	
LVRT K Factor		2.0	0	10,0	0,1	VDE-AR-N 4110: 2018
LVRT K Factor		5.0	0	10,0	0,1	VDE-AR-N 4120: 2018
Gradient for active power increase after fault recovery	%Pn/s	90	--	--	--	Pn: Rated active power. Just after LVRT drops
Others						
Islanding judge criteria (When select 'Frequency change protection')	--	Frequency change				Close / Frequency change / Phase Change / Frequency and phase changes
Frequency change	Hz/s	2,000	0,100	10,000	0,001 Hz/s	
Protection time	s	0,50	0,12	300,00	--	
Active speed control (When select 'Active power adjustment')	--	ON	--	--	--	ON / OFF
Active Power Decline Speed	%Pn/min	39	3	6000	1%Pn/min	Power decrease
Active Power Rising Speed	%Pn/min	39	3	6000	1%Pn/min	Power increase
Limited power switch	--	ON	--	--	--	ON / OFF
Pac limit	%Pn	100.0	0,0	110,0	--	

Parameter description	Unit	Default Value	Min.	Max.	Step- wide	Note
Active power by setpoint						
Power Limiting switch		ON				ON / OFF
Pac Limit	%Pn	100,0	0	110,0	0,1	Pn: Rated active power
Active speed control		ON				ON / OFF
Active Power Decline Speed	%Pn/min	39	3	6000	1%Pn/min	Power decrease
Active Power Rising Speed	%Pn/min	39	3	6000	1%Pn/min	Power increase
Description of interfaces	--	--	--	--	--	RS485 Interface
Behaviour at P=0	--	--	--	--	--	The inverter stays connected to grid, working at $P < 0,5\%P_n$ the inverter goes to standby mode
Active power reduction at overfrequency						
Over frequency derating	--	ON	--	--	--	ON / OFF
Gradient	%Pref/Hz	40,00	20,08	100,00	--	
F1	Hz	50,20	50,02	55,00	0.01	
P1	%Pn	100,0	0,0	100,0	0,1	
F2	Hz	52,50	50,02	55,00	0.01	
P2	%Pn	8,0	0,0	100,0	0,1	
F3	Hz	52,50	50,02	55,00	0.01	
P3	%Pn	0,0	0,0	100,0	0,1	
Active power drop rate in overfrequency drop	%Pn/min	6000	1	6000	--	
Active power restoration rate after overfrequency drop	%Pn/min	9	1	6000	--	
Overfrequency drop curve	--	A curve	--	--	--	A curve / B curve

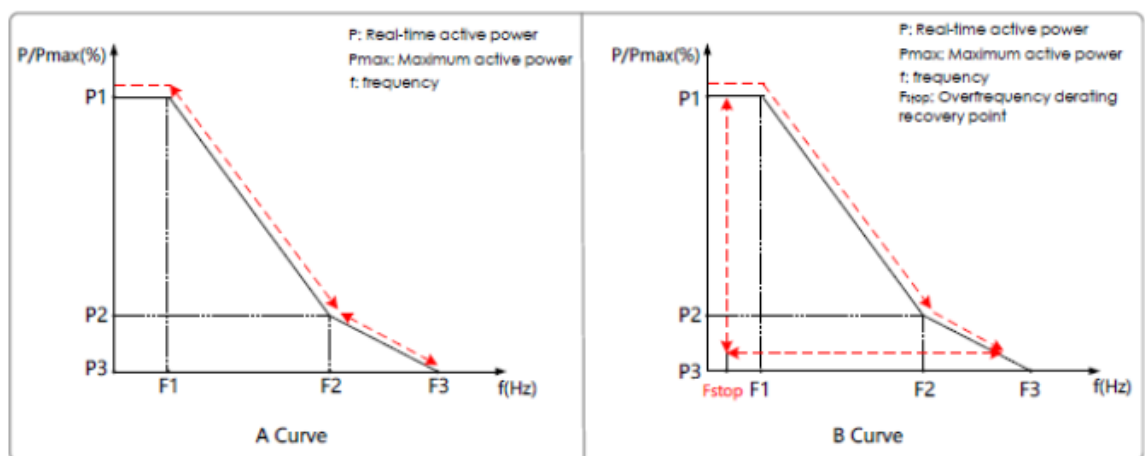

Power reduction at Overfrequency

Parameter description	Unit	Default Value	Min.	Max.	Step- wide	Note
Active power injection at underfrequency						
Underfrequency increment	--	ON	--	--	--	ON / OFF
Gradient	%Pref/Hz	40,00	20,08	100,00	--	The gradient is not a separate parameter. The gradient results from the setting values of parameters F1 to F4 and P1 to P4. With the specified setting values for P1 to P4 and F1 to F4 the required setting range for the gradient (16.67 % Pref / Hz to 100 % Pref / Hz) is fulfilled.
F1	Hz	49,80	45,00	49,98	0.01	
P1	%Pn	0,0	0,0	100,0	0,1	
F2	Hz	49,80	45,00	49,98	0.01	
P2	%Pn	0,0	0,0	100,0	0,1	
F3	Hz	47,50	45,00	49,98	0.01	
P3	%Pn	92	0,0	100,0	0,1	
Active power drop rate in overfrequency drop	%Pn/min	6000	1	6000	--	
Active power restoration rate after overfrequency drop	%Pn/min	9	1	6000	--	
Underfrequency drop curve	--	A curve	--	--	--	A curve / B curve

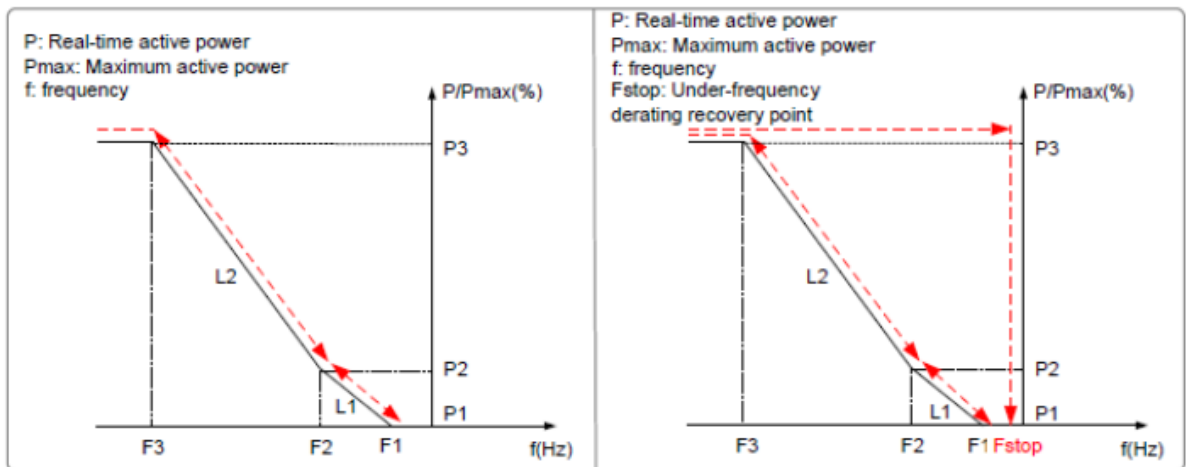

Power increment at underfrequency

As stated in the Manufacturer Declaration for SG110CX (Rev 2, dated on July 3rd, 2020):

“The PV inverter take higher priority for active power rising during frequency drop from 49.8Hz to 47.5Hz temporary than dispatching command by grid operator set point only for SGS test purpose, but the final PV inverter will take higher priority for dispatching command set point”.

Parameter description	Unit	Default Value	Min.	Max.	Step- wide	Note
Reactive power supply						
Reactive power regulation mode (when select 'Reactive adjusting switch')	--	Off	--	--	--	Off / Pf / Qt / Q(P) / Q(U) (Off: The PF is limited to +1,000, and the 'Reactive power limit' is limited to 0,0%)
Reactive power supply. Mode PF: The reactive power can be regulated by the parameter PF (Power Factor).						
PF (when select Pf).	--	1.000	-1,000 ~ -0,800	+1,000 ~ +0,800	0,001	

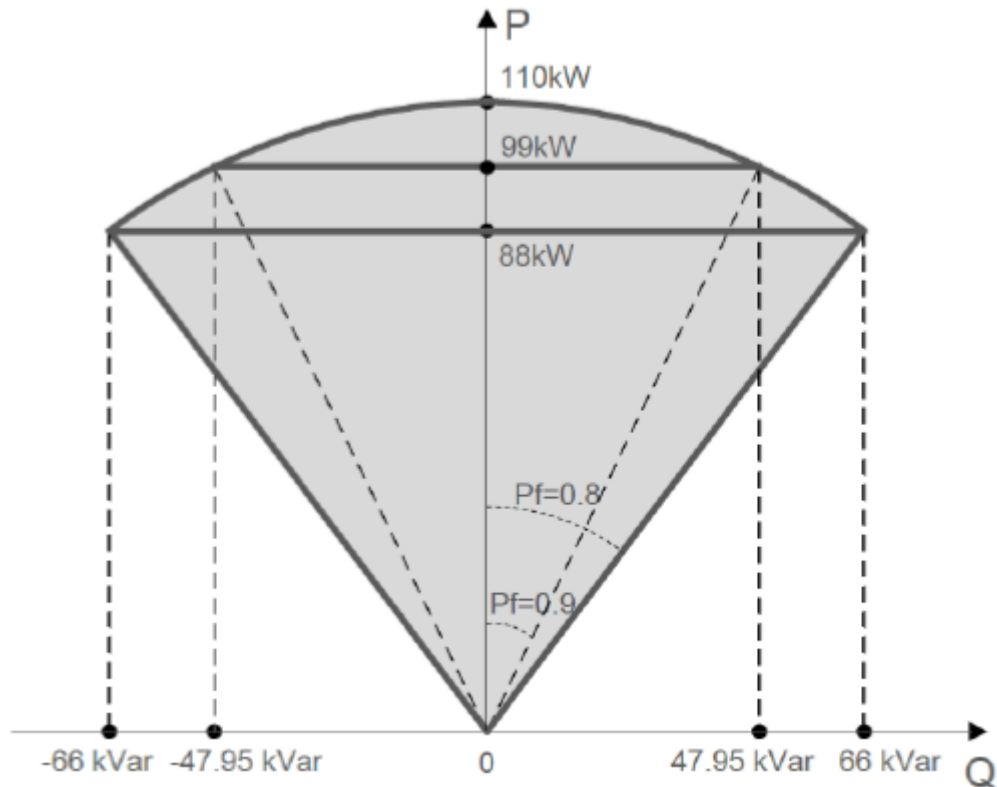

Parameter description	Unit	Default Value	Min.	Max.	Step- wide	Note
Reactive power supply. Mode Qt: The reactive power can be regulated by the parameter 'Reactive power limit' (in %).						
Reactive power limit (when select Qt).	%	0,0	-100,0	+100,0	0,1	

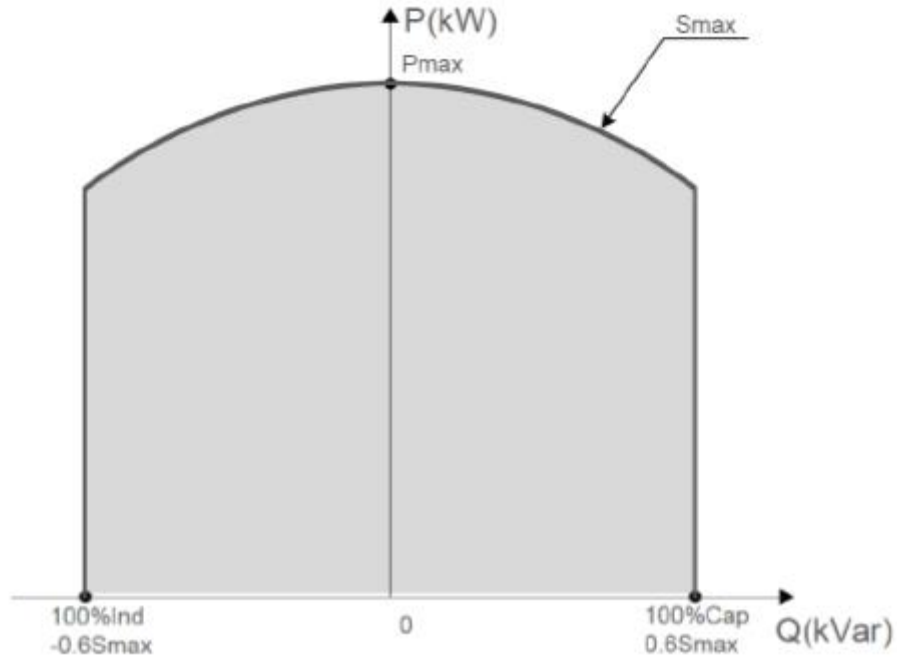

Reactive power supply. Mode Q(P): The reactive ratio or power factor changes with the output power of the inverter.						
Q(P) Curve (when select Q(P))	--	B curve	--	--	--	A curve / B curve (A curve set for power factor; B curve set for reactive ratio)
Active power ratio PA	%	50,0	10,0	100,0	0,1	
Active power ratio PB	%	60,0	20,0	100,0	0,1	
Active power ratio PC	%	90,0	20,0	100,0	0,1	
Corresponding reactive ratio or power factor of active power ratio PA point	p.u.	0,000	-0,660	+0,660	0,001	
Corresponding reactive ratio or power factor of active power ratio PB point	p.u.	0,050	-0,660	+0,660	0,001	
Corresponding reactive ratio or power factor of active power ratio PC point	p.u.	0,330	-0,660	+0,660	0,001	

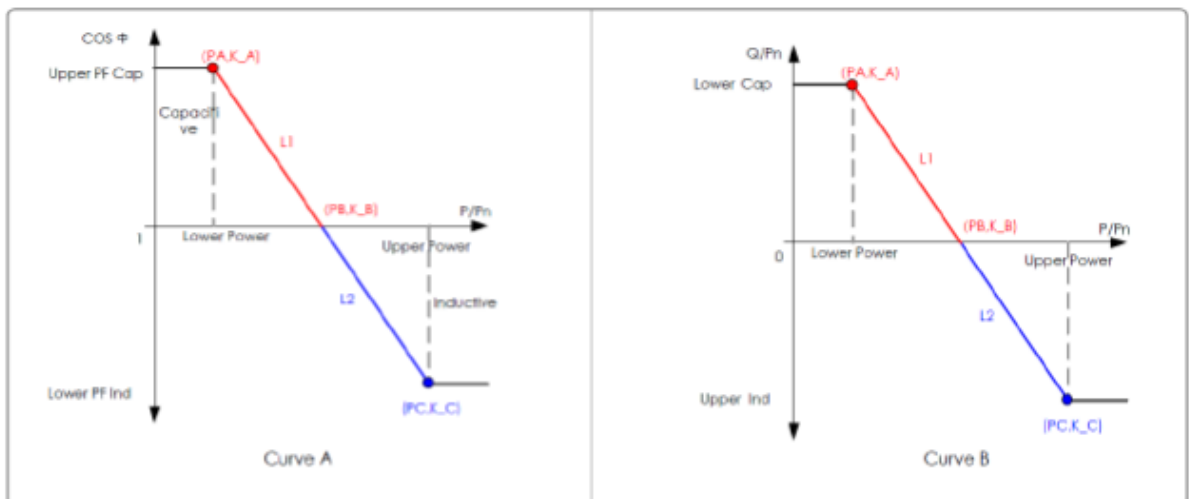

Parameter description	Unit	Default Value	Min.	Max.	Step- wide	Note
Reactive power supply. Mode Q(U): The reactive power changes with the grid voltage.						
Q(U) curve	A curve					A curve / B curve (A curve set for reactive power with voltage limiting function); B curve set for reactive power voltage characteristic Q(U))
Hysteretic proportion	%	0,0	0,0	5,0	0,1	
Voltage proportion U1	%	94,0	80,0	100,0	0,1	B curve: 96,0% for VDE 4110; 95,0% for VDE 4120
Voltage proportion U2	%	96,0	80,0	100,0	0,1	B curve: 100,0%
Voltage proportion U3	%	104,0	100,0	120,0	0,1	B curve: 100,0%
Voltage proportion U4	%	106,0	100,0	120,0	0,1	B curve: 104,0% for VDE 4110; 105,0% for VDE 4120
Corresponding reactive ratio of voltage proportion U1	%	-33,0	-66,0	0,0	0,1	
Corresponding reactive ratio of voltage proportion U2	%	0,0	-66,0	+66,0	0,1	
Corresponding reactive ratio of voltage proportion U3	%	0,0	-66,0	+66,0	0,1	
Corresponding reactive ratio of voltage proportion U4	%	+33,0	0,0	+66,0	0,1	
Reactive response	--	ON	--	--	--	ON / OFF
Reactive response time	s	10,0	0,1	600,0	0,1	VDE-AR-N 4110: 2018
Reactive response time	s	5,0	0,1	600,0	0,1	VDE-AR-N 4120: 2018

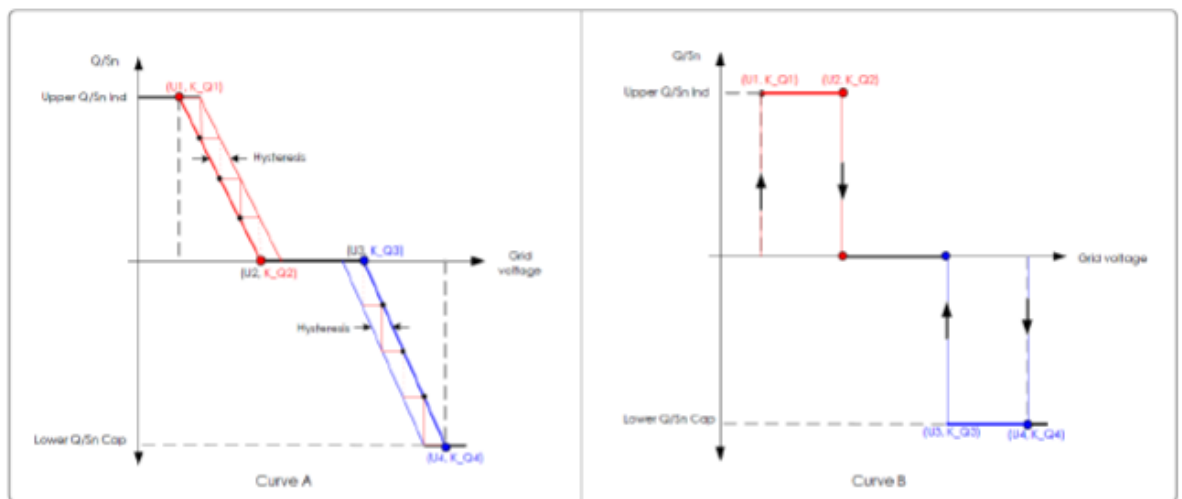

Parameter description	Unit	Default Value	Min.	Max.	Step- wide	Note
Limits for re-energizing (reconnection after fault event)						
Undervoltage Protection Recovery Value	V	218,5	0,1	230,0	0,1	VDE-AR-N 4110: 2018 and VDE-AR-N 4120: 2018
Overvoltage Protection Recovery Value	V	251,0	230,1	321,9	0,1	VDE-AR-N 4110: 2018 and VDE-AR-N 4120: 2018
Underfrequency Protection Recovery Value	Hz	49,90	45.02	49.98	0,01	VDE-AR-N 4110: 2018 and VDE-AR-N 4120: 2018
Overfrequency Protection Recovery Value	Hz	50,10	50.02	54.98	0,01	VDE-AR-N 4110: 2018 and VDE-AR-N 4120: 2018
Fault Recovery Time	s	600	0	3600	1	
Fault Recovery Active Soft Start		ON				ON / OFF
Fault Recovery Active Soft Start Time	s	600	1	1200	1	Takes 600s from 0%Pn to 100%Pn
Limits for connection (without previous trip)						
Grid Connection Condition		ON	--	--	--	ON/OFF
Grid Connection Voltage Minimum	p.u.[%]	90,0	50,0	100,0	0,1	VDE-AR-N 4110: 2018 and VDE-AR-N 4120: 2018
Max. Grid-connected Voltage	p.u.[%]	110,0	100,0	120,0	0,1	VDE-AR-N 4110: 2018 and VDE-AR-N 4120: 2018
Grid Connection Frequency Minimum	Hz	47,50	47,00	49,98	0.01	VDE-AR-N 4110: 2018 and VDE-AR-N 4120: 2018
Max. Grid-connected Frequency	Hz	50,20	50,02	52,00	0.01	VDE-AR-N 4110: 2018
Max. Grid-connected Frequency	Hz	51,00	50,02	52,00	0.01	VDE-AR-N 4120: 2018
Grid Connection Detection Time	s	60	10	900	1	
Grid-connected Active Power Rising Rate	% Pn /min	39	3	6000	1	Pn: Rated active power

Parameter description	Unit	Default Value	Min.	Max.	Step- wide	Note
Protective functions						
AC Over-voltage Level 1 Protection Value	V	287,5	230,0	322,0	0,1 V	VDE-AR-N 4110: 2018 and VDE-AR-N 4120: 2018
AC Over-voltage Level 1 Protection time	s	0,10	0,05	14400,00	0,01 s	VDE-AR-N 4110: 2018 and VDE-AR-N 4120: 2018
AC Over-voltage Level 2 Protection Value	V	287,5	230,0	322,0	0,1 V	VDE-AR-N 4110: 2018 and VDE-AR-N 4120: 2018
AC Over-voltage Level 2 Protection time	s	0,10	0,05	14400,00	0,01 s	VDE-AR-N 4110: 2018 and VDE-AR-N 4120: 2018
AC Under-voltage Level 1 Protection Value	V	184,0	23,0	230,0	0,1 V	VDE-AR-N 4110: 2018 and VDE-AR-N 4120: 2018
AC Under-voltage Level 1 Protection Time	s	1,00	0,05	14400,00	0,01 s	VDE-AR-N 4110: 2018
AC Under-voltage Level 1 Protection Time	s	2,40	0,05	14400,00	0,01 s	VDE-AR-N 4120: 2018
AC Under-voltage Level 2 Protection Value	V	103,5	23,0	230,0	0,1 V	VDE-AR-N 4110: 2018
AC Under-voltage Level 2 Protection Time	s	0,30	0,05	14400,00	0,01 s	VDE-AR-N 4110: 2018
AC Under-voltage Level 2 Protection Value	V	69,0	23,0	230,0	0,1 V	VDE-AR-N 4120: 2018
AC Under-voltage Level 2 Protection Time	s	0,80	0,05	14400,00	0,01 s	VDE-AR-N 4120: 2018
Grid Overfrequency Level 1 Protection Value	Hz	51,50	50,04	55,00	0,01 Hz	VDE-AR-N 4110: 2018 and VDE-AR-N 4120: 2018
Grid Overfrequency Level 1 Protection Time	s	5,00	0,05	14400,00	0,01 s	VDE-AR-N 4110: 2018 and VDE-AR-N 4120: 2018
Grid Overfrequency Level 2 Protection Value	Hz	52,50	50,04	55,00	0,01 Hz	VDE-AR-N 4110: 2018 and VDE-AR-N 4120: 2018
Grid Overfrequency Level 2 Protection Time	s	0,10	0,05	14400,00	0,01 s	VDE-AR-N 4110: 2018 and VDE-AR-N 4120: 2018
AC Under-frequency Level 1 Protection Value	Hz	47,50	45,00	49,96	0,01 Hz	VDE-AR-N 4110: 2018 and VDE-AR-N 4120: 2018
AC Under-frequency Level 1 Protection Time	s	0,10	0,05	14400,00	0,01 s	VDE-AR-N 4110: 2018 and VDE-AR-N 4120: 2018
AC Under-frequency Level 2 Protection Value	Hz	47,50	45,00	49,96	0,01 Hz	VDE-AR-N 4110: 2018 and VDE-AR-N 4120: 2018
AC Under-frequency Level 2 Protection Time	s	0,10	0,05	14400,00	0,01 s	VDE-AR-N 4110: 2018 and VDE-AR-N 4120: 2018

Parameter description	Unit	Default Value	Min.	Max.	Step- wide	Note
Protective functions						
Evaluation of conductor-conductor or conductor-earth voltage						Every conductor-earth voltage
Logical AND or OR link						OR
Self-protection overvoltage (transient)			140% of the rated voltage and 1 ms			

CAPABILITY OF PRIMARY CONTROL ENERGY SUPPLY.

As stated in the Manufacturer Declaration for SG110CX (Rev 2, dated on July 3rd, 2020):

“The SG110CX is in full capacity if necessary, to supply primary control of energy supply. The inverter can fulfil the requirements stated by figure 22 and table 9 of the VDE-AR-N 4120:2018. These system services are, in fact, provided by the transmission network operator and the requirements for the power generating plants comprise the capability of “frequency-dependent active power adjustment in normal network operation” or the capability of “signal-controlled active power adjustment”, respectively.”.



In addition to the parameters listed here, the inverter has a corresponding setting of the respective country (see Figure below). This is important because not all parameters relevant at the plant level are visible or adjustable for the user but are partially implemented.

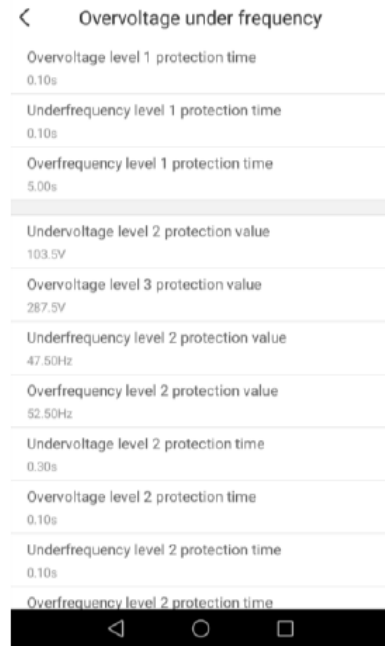
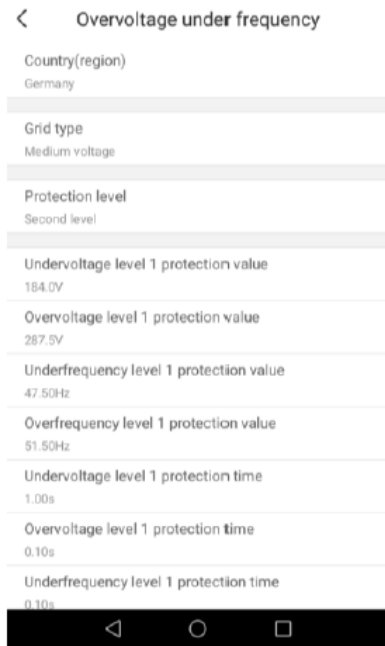
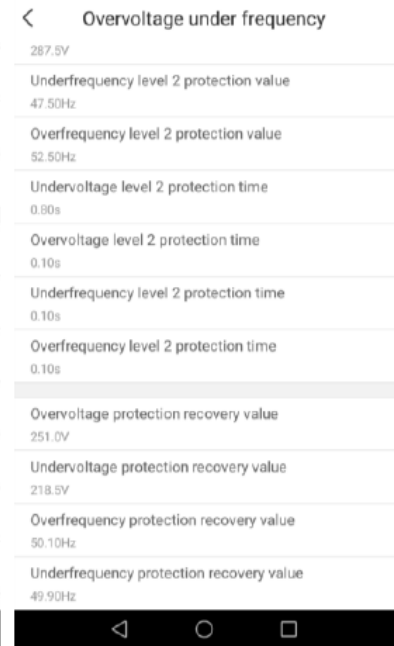
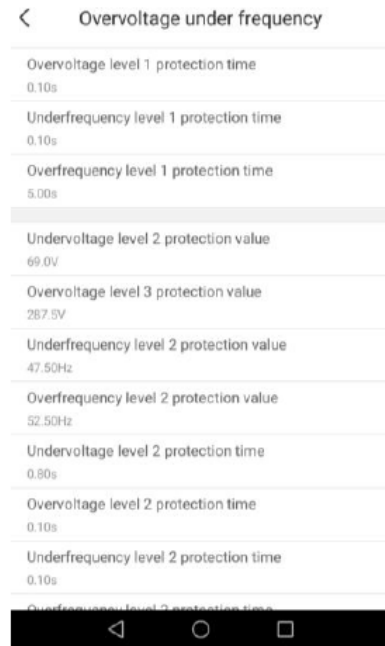
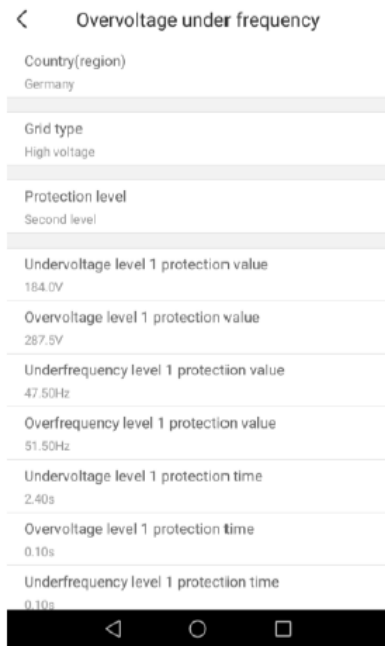

"Germany" stands for the German country.

If further information on parameters is required, you should ask the manufacturer.

4.3 Electric scheme

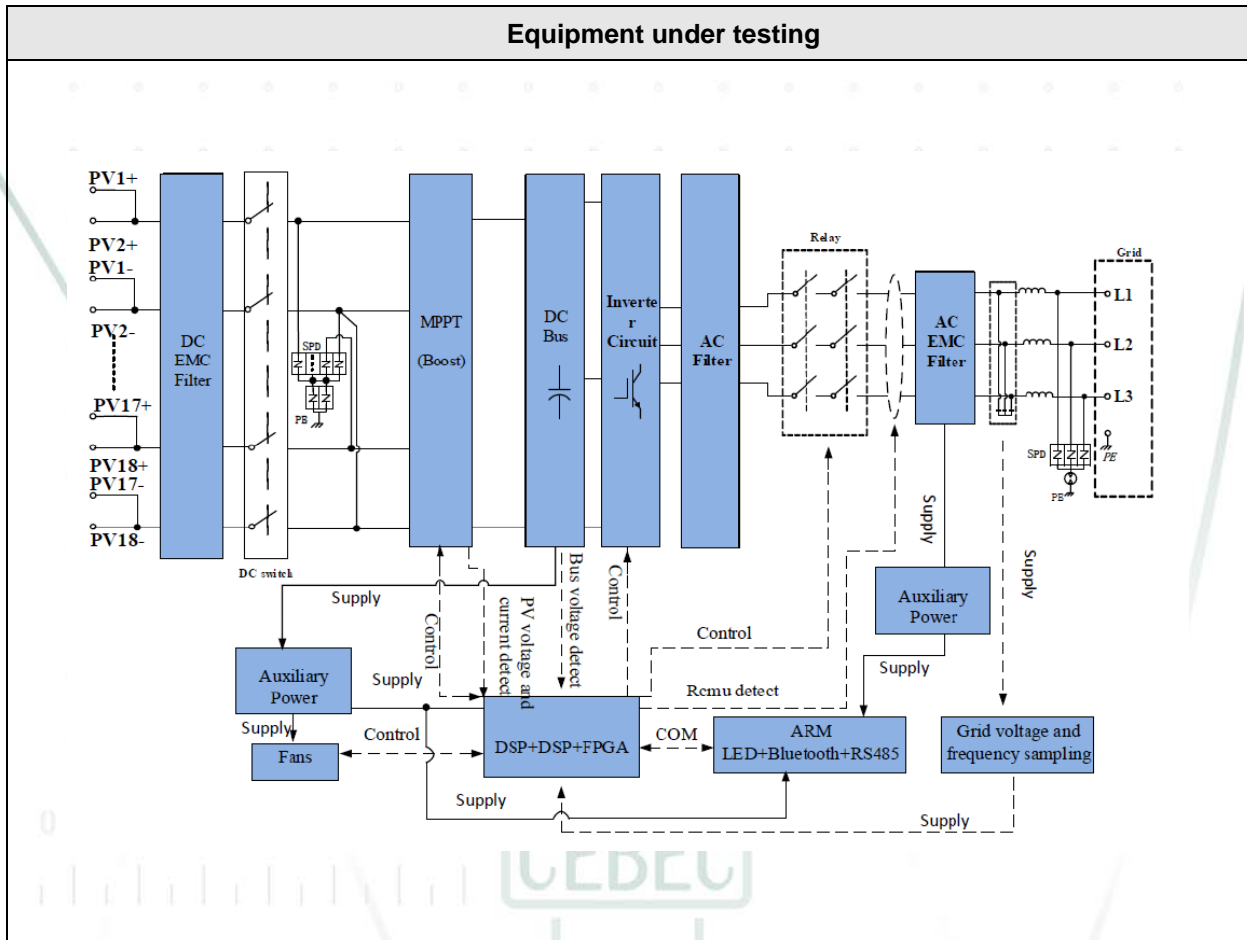

4.4 Interfaces

The following figure shows the position of the communication wiring board in the inverter as well as the terminals equipped for the wiring board.

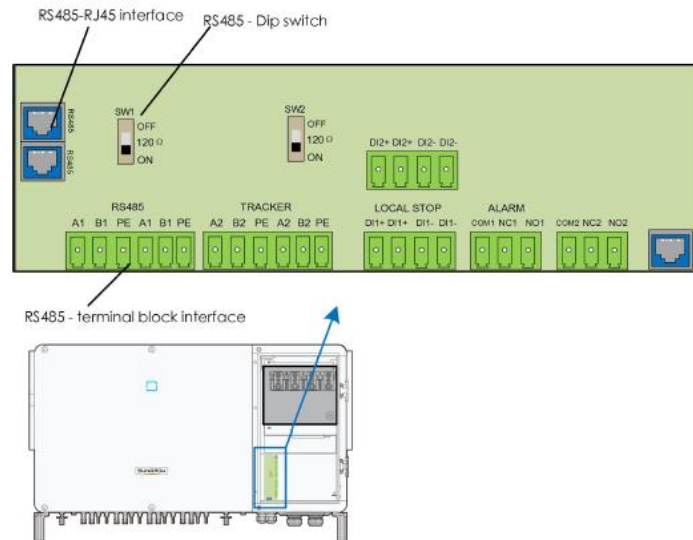

The inverter is equipped with two groups of RS485 communication interfaces for external communication connection. Both the two groups of interfaces can be connected to the data collector (Logger), to achieve data exchange with PC or other monitoring devices.

When multiple inverters are connected in the RS485 daisy chain, a 120Ω terminating resistor can be connected between the A and B communication cable through the RS485-dip switch, to ensure communication quality.

Note: The terminal block interface and RJ45 interface have the same function with only wiring manner different. Select either interface for cable connection.

4.5 Manufacturer's certificates for certified PGUs according to FGW TG3

Manufacturer Certificate according to FGW TG3			
Herstellerbescheinigung zu spezifischen Daten eines Photovoltaik-Wechselrichters vom Typ SG110CX			
Manufacturer's certificate on specific data of a Photovoltaic Converter of the type SG110CX			
Datum / Date: 10/03/2021			Seite/Page 1/1
1	Allgemeines und Ausgangsgrößen		General and Output values
1	Hersteller	Sungrow Power Supply Co., Ltd.	manufacturer
2	Typenbezeichnung	SG110CX	type name
3	Einspeisung (einphasig/drephasig)	three-phase	no. of phases (single-phase/three-phase)
4	Nennscheinleistung	110 kVA	rated apparent power
5	Nennwirkleistung	100 kW	rated active power
6	AC-Nennspannung	400,3/N/PE V	rated AC-voltage
7	AC-Nennfrequenz	50/60 Hz	rated frequency
8	Beitrag zum Stoßkurzschlussstrom	0.38 kA	contribution to short circuit current
2	DC Eingangsgrößen		DC Input
1	Min. MPP-Spannung	200 V	min. MPP voltage
2	Max. MPP-Spannung	1000 V	max. MPP voltage
3	Max. PV-Eingangsspannung	1100 V	max. DC Input voltage

0 1 2 3 4 5



4.6 Behaviour in the event of a failure of either the PGP controller or the associated measurement or the connection between PGP controller and PGU

When the inverter detects the communication interruption with the monitoring system, it needs to operate according to the preset active and reactive power.

If the inverter detects no valid data interaction with the monitoring system for a period of time, the communication is considered interrupted. Working according to preset active and reactive power configuration parameters. If the inverter detects that the communication is restored, the inverter will return to the active and reactive power parameters before the communication interruption.

When communication interruption is enabled, the interruption time shall be recorded.

If the interruption time reaches the preset communication interruption time, the operation shall be conducted according to the preset active and reactive power parameters.

Under the condition of communication recovery enabling, the current state is in the state of communication interruption. When a normal communication message is received and the time reaches the set value of communication recovery time, the communication is considered restored. At this time, the inverter operates according to the active and reactive power parameters at the last communication time.

5 DYNAMIC SIMULATION MODEL INFORMATION

5.1 Software Characteristics

- Software type: Simulator for Grid Connected Power Conversion System
- Simulation platform: DigSilent PowerFactory
- Used version of the simulation platform: 15.2.9 (*)
- Simulation Software File identification: Project for SG110CX.pfd
- Dynamic Simulation Model version: V6
- MD5 Checksum: 326DBE8E8653557F34370591C169F8D5

(*) Simulation results offered in the validation report were obtained with the Powerfactory Digsilent Version 15.2.9. The validation report doesn't cover upper version of Digsilent above V15.2.9.

Revision 2

Report Number: 2219 / 0375 / A - TG4 demonstrates that the updated Dynamic Simulation Model (version 3.0) does not show any critical change compared to the previous version used in the original report number 2219 / 0375 - TG4. For more details see clause 3.1.3 of this Annex to Certificate

Software Characteristics used on Report 2219 / 0375/ A - TG4

- Software type: Simulator for Grid Connected Power Conversion System
- Simulation platform: Digsilent Power Factory 2021 SP4B
- Used version of the simulation platform: Version 21.0.6.0 (*)
- Simulation Software File identification: VDE_SG110CX_PF2019.pfd
- Dynamic Simulation Model version: V3.0
- MD5 Checksum: 3FCC9FA23AE8972266BE9028106FE02A

(*) Simulation results offered in the validation report were obtained with the Powerfactory Digsilent Version 21.0.6.0. The validation report doesn't cover upper version of Digsilent above Version 21.0.6.0.

Revision 3

Report Number: 2219 / 0375 / A – E1 - TG4 contains the updated MD5 Checksum reference due to a typo in previous MD5 Checksum reference.
The dynamic simulation model itself has not changed, therefore no further testing is required.

Software Characteristics used on Report 2219 / 0375/ A – E1 - TG4

- Software type: Simulator for Grid Connected Power Conversion System
- Simulation platform: Digsilent Power Factory 2021 SP4B
- Used version of the simulation platform: Version 21.0.6.0 (*)
- Simulation Software File identification: VDE_SG110CX_PF2019.pfd
- Dynamic Simulation Model version: V3.0
- MD5 Checksum: 03383A92CB1A1C003CA3A000C295CB6B

(*) Simulation results offered in the validation report were obtained with the Powerfactory Digsilent Version 21.0.6.0. The validation report doesn't cover upper version of Digsilent above Version 21.0.6.0.

5.2 Software Information and Comments

As evidenced in the manufacturer's documentation and the validation report, the dynamic model could be completely able to represent the dynamic behaviours at the PV inverter terminal, and also be suitable for power grid studies. The dynamic model covered by the validation report is valid for fundamental frequency positive and negative sequence response. The dynamic model is developed with the following specifications in mind:

- The model is to be used primarily for power system stability studies and thus should represent all positive and negative sequence dynamics affected and relevant during:
 - Balanced and unbalanced short-circuits on the transmission grid (including voltage recovery)
 - Grid frequency disturbances
 - Reference value changes
- The model is for fundamental frequency positive and negative sequence response.
- The model is valid for typical power system frequency deviations.
- The model is able to handle numerically the simulation of phase jumps.
- The model is valid for steady state voltage deviations within the range from 0,9 p.u. to 1,1 p.u.
- The model is valid for dynamic voltage phenomena (e.g. faults) where the voltage can dip temporarily close to zero and up to 1,25 p.u.
- The typical dynamic simulation time frame of interest is from 5 seconds to 800 seconds.
- The model could work with integration time step range from 0,001s to 0,01s.
- The model could be initialized to a steady state from load flow solutions at full or partial nominal power.
- External conditions like solar radiation are taken into account through the available PV array conversion power.
- Over/under frequency and over/under voltage protections are modelled in the control model in order to allow a realistic representation of PV inverter disconnection following grid disturbances. This may be separate modules that connect to the main PV inverter model.
- The model includes the reactive power capability of the PV inverter.

5.3 Description of the model

The model has the following design:

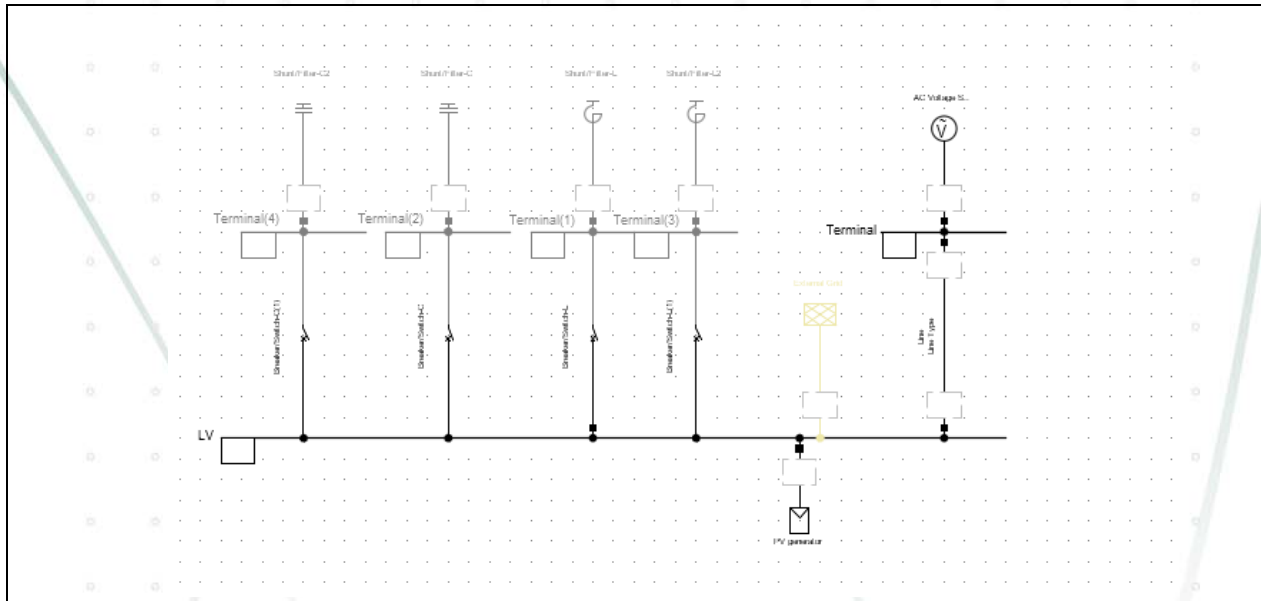

The grid information of SG110CX Digsilent project is as follows:

	SCR implemented in the simulated grid	Sampling resolution of simulation results
Validation requirements for Voltage Ride Through (LVRT and HVRT)	5	1 kHz (Step size is 1 ms)
Validation requirements for Reactive Power Control processes (QvsU and QvsP)	50	0,1 kHz (Step size is 10 ms)
Verification of requirements for Protective Settings (Under/Over voltage cases)	5	1 kHz (Step size is 1 ms)
Verification of requirements for Protective Settings (Under/Over frequency cases)	50	1 kHz (Step size is 1 ms)
Plausibility checks with Kmin and K factor for P.2 and P.3 cases	5	1 kHz (Step size is 1 ms)
Plausibility checks with Kmax cases	50	1 kHz (Step size is 1 ms)

For further information, see the “User Manual and Model Description of DigSILENT PowerFactory Model of SG110CX PV Inverter” (version 3, issued on 3rd December 2021).

The SCR is calculated by:

$$SCR = MSk/Pn$$

Where, MSk is the short-circuit capacity of interconnected of point, Pn is the rated capacity of inverter.

And the impedance Zk of grid is calculated by:

$$Zk = SCR * Pn / (1.732 * Ug^2)$$

Where, Ug is the rated voltage of inverter. The resistance is 10% of reactance for impedance.

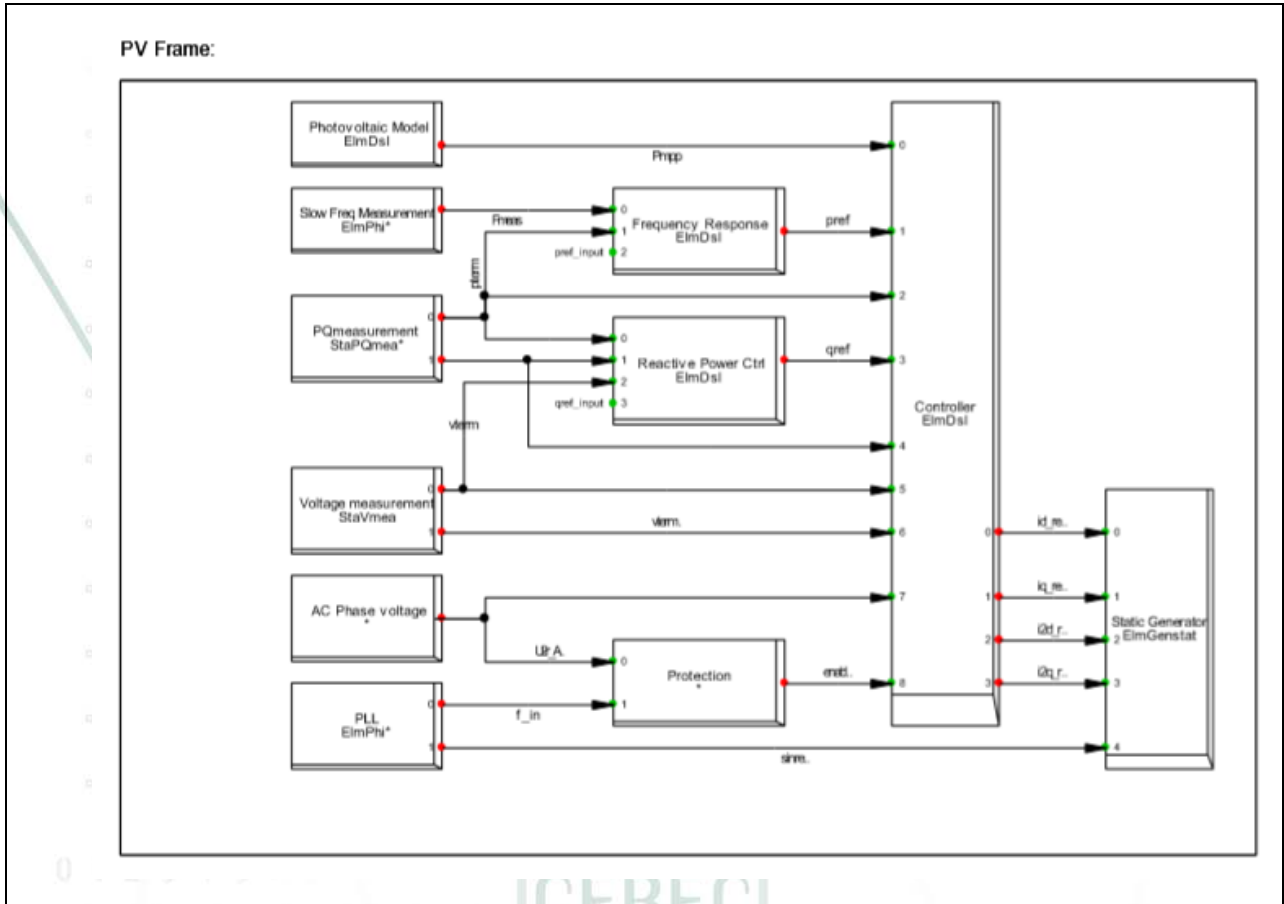

Below is showed the composite model linked with the PV-frame

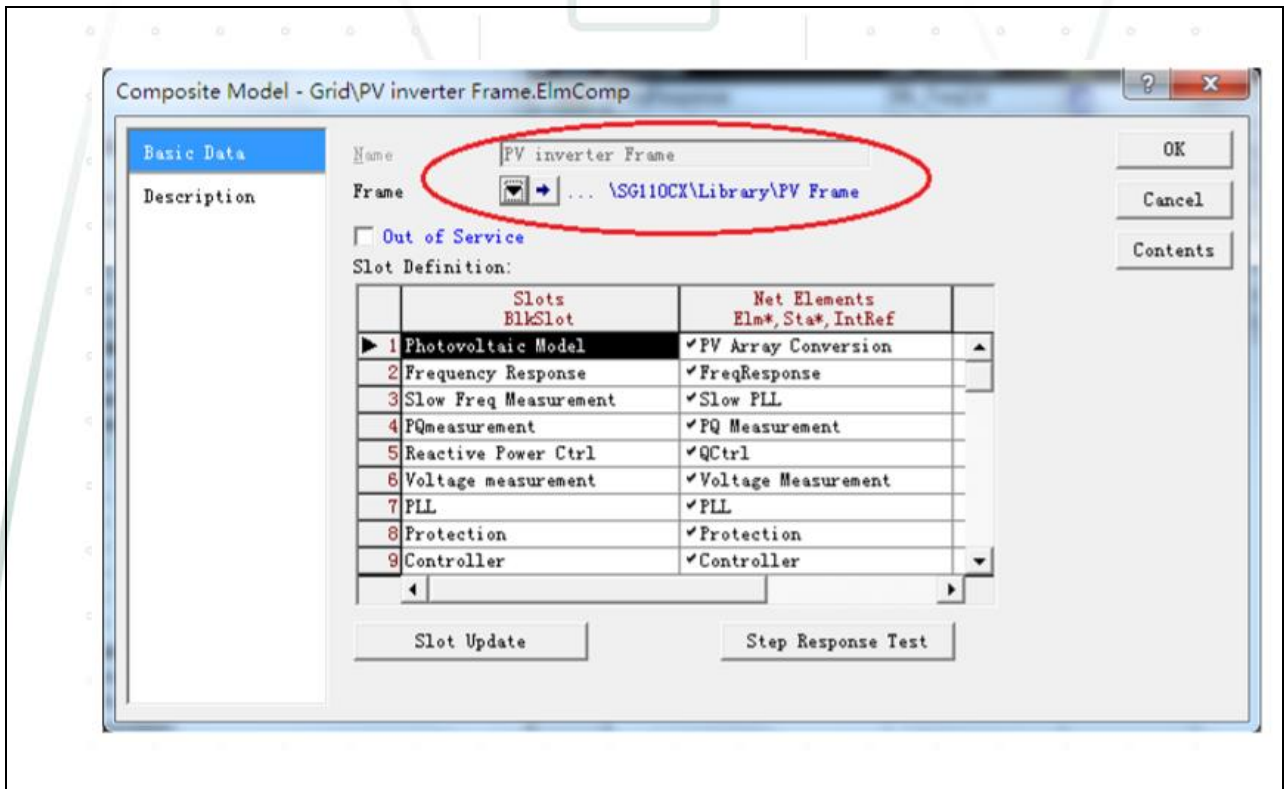

This controller block allows the user to configure main adjustable parameters of the simulated conversion system for LVRT/HVRT tests

The following picture shows parameters adjusted by default for the simulations offered in this report.

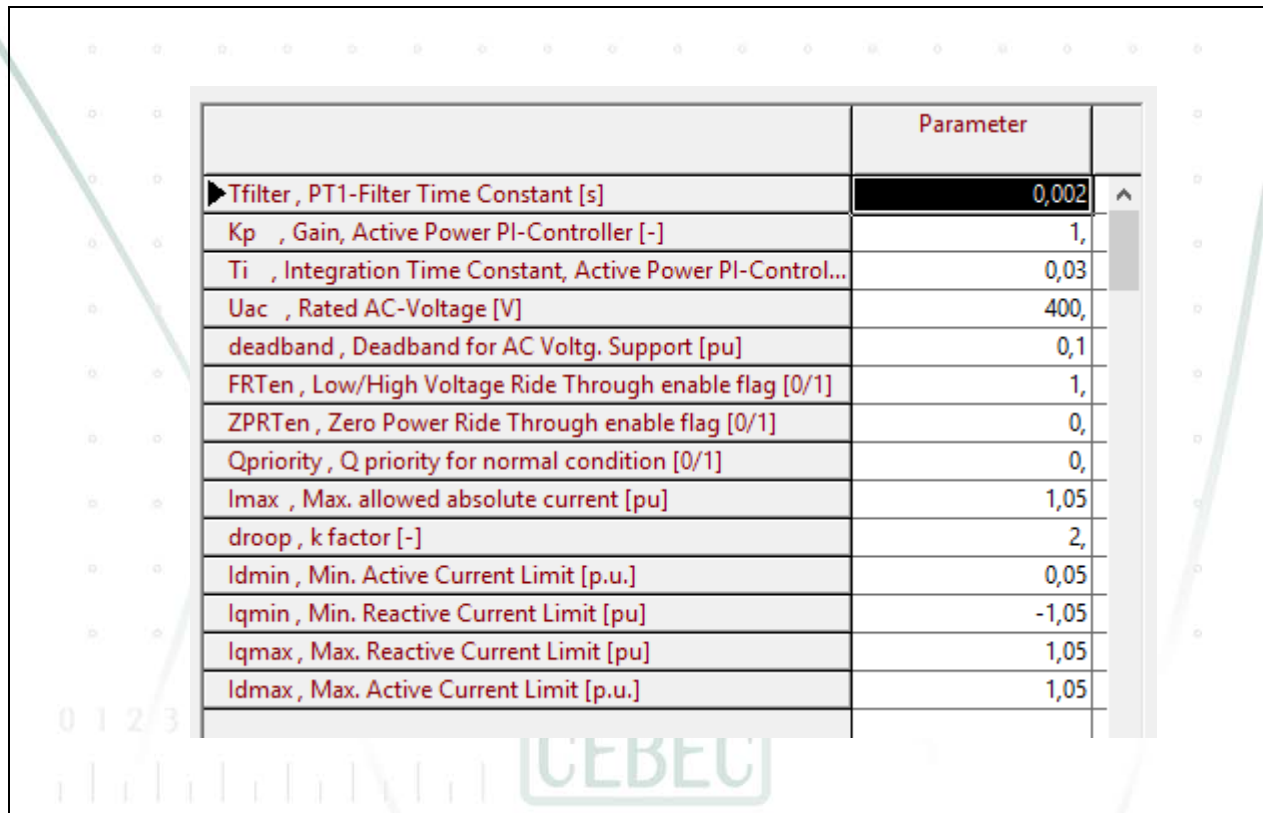

	Parameter	
▶ Tfilter , PT1-Filter Time Constant [s]	0,002	^
Kp , Gain, Active Power PI-Controller [-]	1,	
Ti , Integration Time Constant, Active Power PI-Contro...	0,03	
Uac , Rated AC-Voltage [V]	400,	
deadband , Deadband for AC Voltg. Support [pu]	0,1	
FRTen , Low/High Voltage Ride Through enable flag [0/1]	1,	
ZPRTen , Zero Power Ride Through enable flag [0/1]	0,	
Qpriority , Q priority for normal condition [0/1]	0,	
I _{max} , Max. allowed absolute current [pu]	1,05	
droop , k factor [-]	2,	
I _{dmin} , Min. Active Current Limit [p.u.]	0,05	
I _{qmin} , Min. Reactive Current Limit [pu]	-1,05	
I _{qmax} , Max. Reactive Current Limit [pu]	1,05	
I _{dmax} , Max. Active Current Limit [p.u.]	1,05	

Just following parameters needs to varied depending the FRT case to evaluate:

- Droop, K factor
- ZPRTen, Zero Power Ride Through enable flag (this enables, with 1, or disables, with 0, the Limited Dynamic Grid Support Mode)

LVRT/HVRT simulated signals are configured through different short circuit evens similar to those detailed below:

Parameter\Dip depth	0%	30%	53%	72%
Short circuit resistance(Ω)	0.0000038	0.000038	0.000009	0.000009
Short circuit reactor(Ω)	0.000014	0.00013	0.00036	0.001085
Fault duration (ms)	250	730	1068	1790

These are configured as short-circuit events indicating phases affected by the dip event as corresponds.

Simulation Events/Fault - Study Cases\LVRT_validation\25.4\Simulation Events/Fault :

	Name	Breaker or Element StaSwitch,StaCub...	Absolute h	Absolute min	Absolute s	Event defined by Elm*	Action	All phases	Phase a	Phase b	Phase c
*	Switch Event	Breaker/Switch-L	0	0	10,306		1	<input type="checkbox"/>	<input type="checkbox"/>	<input checked="" type="checkbox"/>	<input checked="" type="checkbox"/>
*	Switch Event(1)	Breaker/Switch-L	0	0	11,819		0	<input type="checkbox"/>	<input type="checkbox"/>	<input checked="" type="checkbox"/>	<input checked="" type="checkbox"/>

Flexible Data / Characteristics / Distributions / Basic Data / Description / Load Flow / Short-Circuit VDE/IEC / Short-Circuit Complete / Short-Circuit ANSI

The type of fault and short-circuit configurations are set in the shunt (L/C) configuration:

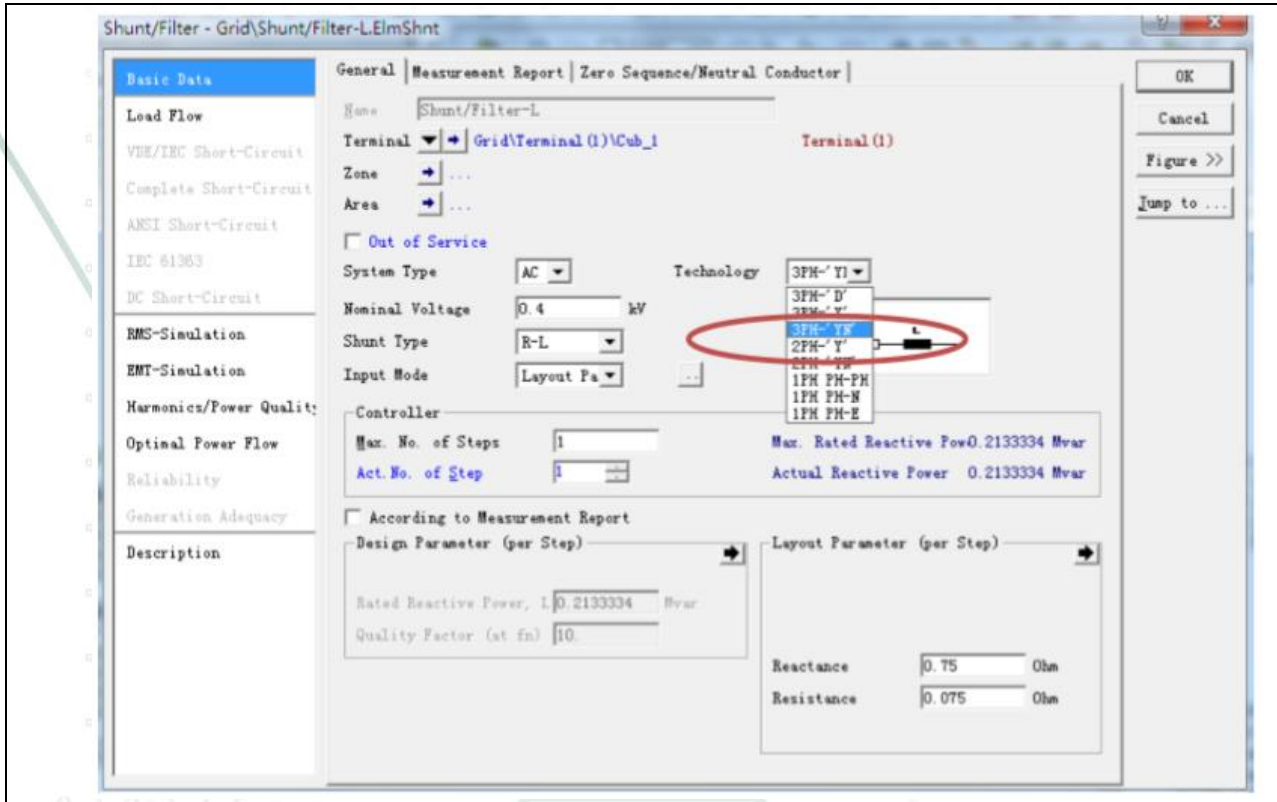

The slack node can also be configured for plausibility tests.

